

Operating Instructions

translation



EC type examination certified





Zertifiziertes QM-System
nach DIN ISO 9001:2000



CONTENTS:

- Safety Instructions 
- Application
- Instruction for use
- Mechanical data
- Electrical connection
- Putting into operation

chapter	contents	page
1	Indicator lights on Frontpanel and switches for safe operation.....	3 - 4
2	General Safety Instructions 	5
2.1	Prerequisites for using the press brake protection AKAS® 	6-7
3	Description and fields of application for the equipment.....	8
3.1	General Instructions	8
3.2	Function Description / Characteristics	9
3.3	Function description during bending of flat sheet metal / bending of wavy sheet metal	10-11
3.4	Function description during Box bending / bending of small items	12
4	Mechanical data, dimension drawings.....	13
4.1	AKAS®-3PM / -3PF	13
4.2	max. Standard-Range,max. positioning range of the supports, Fiessler holders.....	14
5	Mounting.....	15
5.1	How to proceed during the mounting of the AKAS® -system	15
5.2	1a. Overrun Traverse Measuring / 1b. Dip Switch Adjustment	15
5.3	2. Design of a Mechanical Suspension Device - void if Fiessler holders are used	16
5.4	3. Mounting of the suspension devices at the ram	16
5.5	4. Mounting of the AKAS® components on the holders	17
5.7	6. Adjustment of the AKAS® during first installationn	18
5.8	7. Adjustment of the distance of the AKAS® from the bending punch (self-acting if supports are used)	22
5.9	8. Function Verification of all electrical connections in view of the safety class 4 requirements	23
5.10	9. Self-Acting Overrun Traverse Test	23
6	Electrical connections -Descriptions / wiring diagrams	24
6.1	Electrical Data	24
6.2	Instructions for Integrating the AKAS® into the machine control system.....	25
6.3	AKAS®-3PM (operation <u>only with</u> additional safety PLC)	26
	Functions / Terminals	26
	Connection.....	27
6.4	AKAS®-3PF -with additional safety functions (operation also <u>without</u> additional safety PLC)	28
	Functions / Terminals	29
	Connection example: safety monitoring of the machine by AKAS®-...F	30
6.4.1	AKAS®-...F -selectable Safety functions	31
	1. Operation with additional safety control	31
	2. Monitoring of the Foot Pedal	31
	Connection: Foot Pedal for 1 Operator / 2 Foot Pedals for 2 Operators	31
	3. Soft-braking if the Foot Pedal was released (Delayed Foot Pedal Reaction)	31
	4. Overrun Traverse Control	31
	5. Monitoring of the Stop Valves (EDM)	32
	6. Monitoring of the door- and the Emergency OFF-circuits, Emergency-OFF of the Motor-driven rear stoppers	32
	Connection: Reset Button wiring for the rear protective grid if operated without EDM	32
	Connection: Safety light Grid (equivalent switching) as rear guard	33
	Connection: Safety light Grid (antivalent switching) as rear guard	33
	7. Installation operation/ protection by monitored slow speed without activated protective field	34
	Connection: when equivalent switching door contacts are used	34
	Connection: when antivalent switching door contacts are used	34
	8. Slow speed traverse information -Connection of traverse measuring device	35
	9. Enhancement of Switching-over tolerances of the valve position monitors	35
6.4.2	Programming of the safety functions by Hex switches	36
6.5	Displaying outputs, Indicator LEDs	38
	-Muting lamp , adjustment control LEDs , indicator LEDs.....	38
	-Outputs via serial RS232-interface	39
7	Service / Maintenance / Warranty.....	42
8	Signals as a function of time, way, rate.....	43-47
9	Order Codes	48
10	AKAS®-Inspection sheet.....	49
11	Declaration of Conformity.....	50
12	Terms.....	51

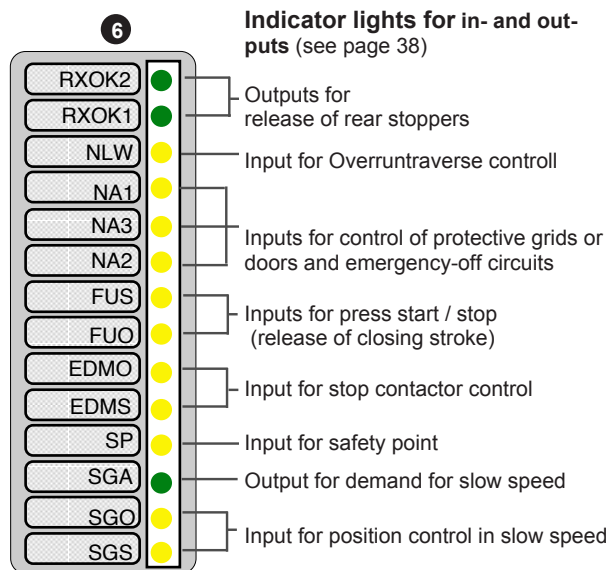
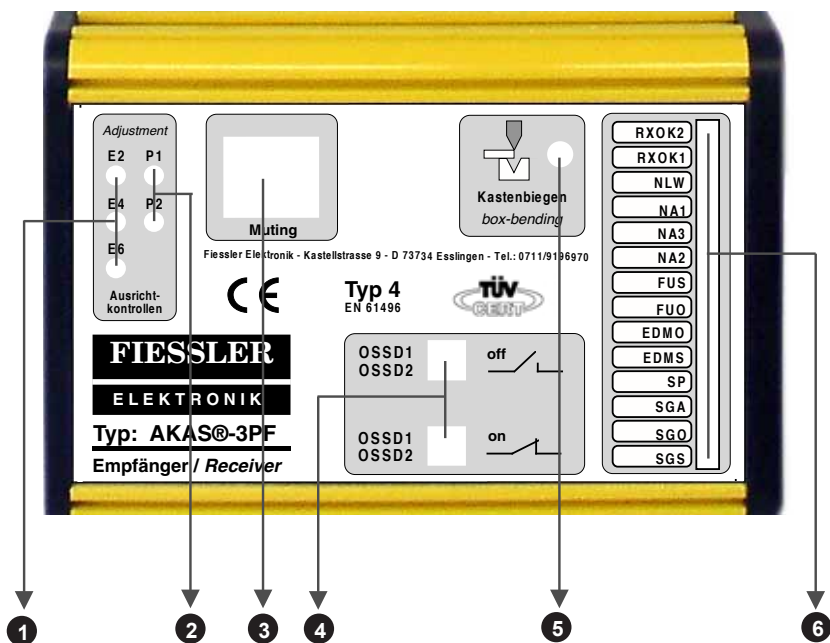

view of the receiver elements

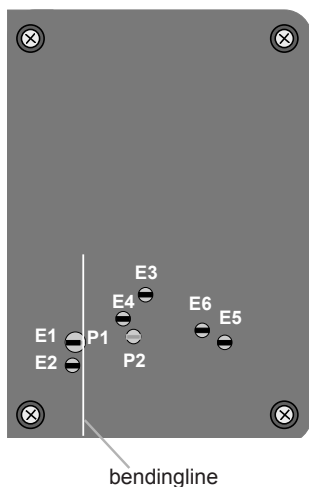

view after removing the lid on the receiver

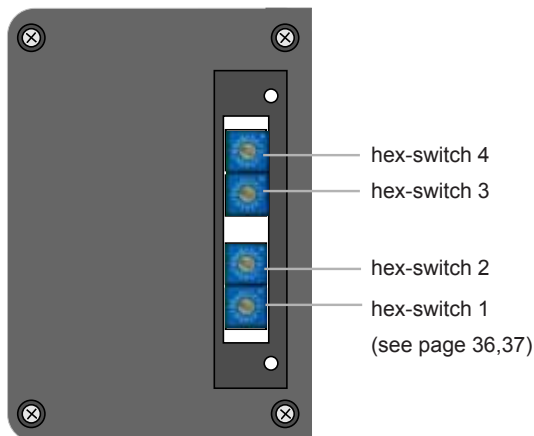

- 1** adjustment control-Leds of the receiver elements E2, E4, E6 LEDs are on if the beam does focus at all (see page 21)
- 2** adjustment control-Leds P1, P2 for self-acting adjustment after tool change LEDs are on if the beam does focus at all (see page 21)
- 3** integrated mutinglamp lamp is on if the protective field of the AKAS is not activated lamp is flashing if EDM- or SP-input-signals are wrong (see page 38)
- 4** LEDs for safety outputs (OSSDs, Fail-Safe PNP) red LEDs are on if the OSSDs are in OFF status green LEDs are on if the OSSDs are in ON status
- 5** LED is on if box bending funktion is activated

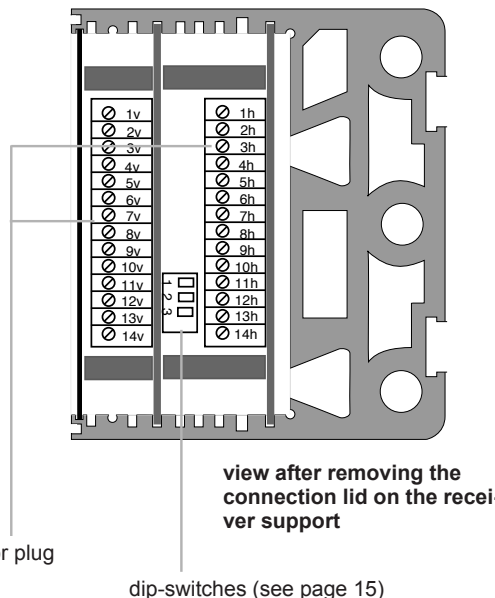

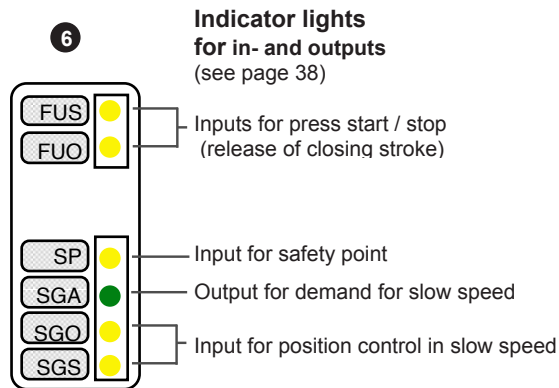
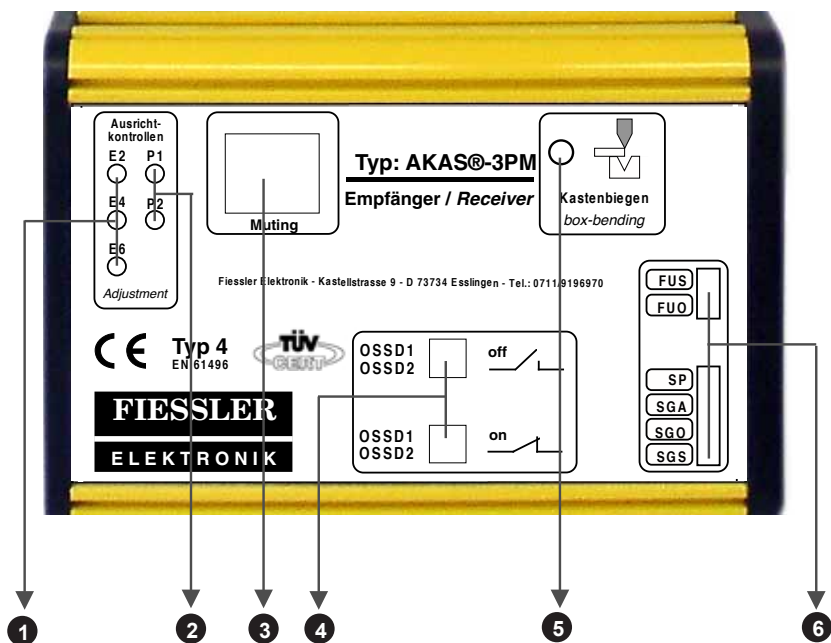

view of the receiver elements

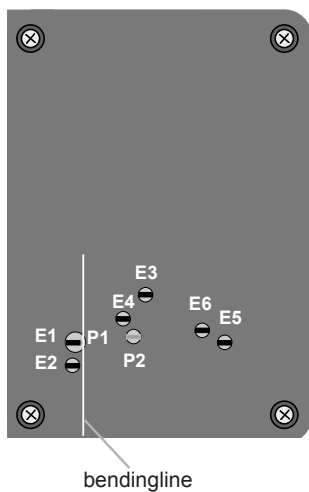

- 1 adjustment controll-Leds of the receiver elements E2, E4, E6 LEDs are on if the beam does focus at all (see page 21)
- 2 adjustment controll-Leds P1, P2 for self-acting adjustment after tool change LEDs are on if the beam does focus at all (see page 21)
- 3 integrated mutinglamp lamp is on if the protective field of the AKAS is not activated lamp is flashing if EDM- or SP-input-signals are wrong (see page 38)
- 4 LEDs for safety outputs (OSSDs, Fail-Safe PNP) red LEDs are on if the OSSDs are in OFF status green LEDs are on if the OSSDs are in ON status
- 5 LED is on if box bending funktion is activated

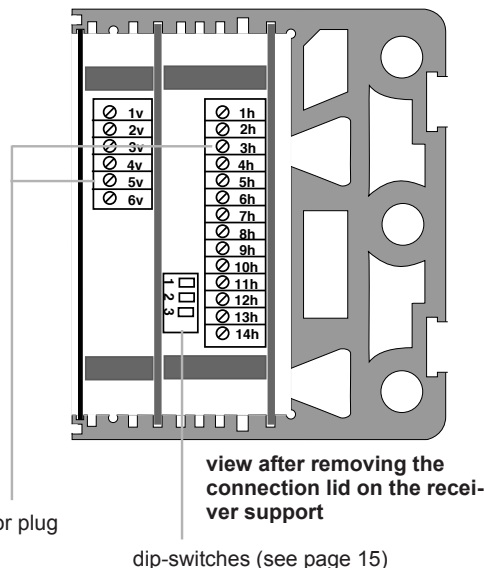

please notice absolutely



This is the operating instruction for the AKAS® models: AKAS®-3PM, AKAS®-3PF. Special instructions for each model are provided with its individual model marking. Attention is drawn to all safety instructions by this symbol.

Read the operating instructions

Particular attention must be paid to such instructions. These operating instructions provide to the user important information concerning the correct use of the AKAS®. These instructions are a component of the light barrier concerned. It is essential that they are easily available at the location where the safety light barrier is installed. Before the initial operation of the AKAS®, all requirements detailed in these operating instructions must be observed. Other relevant regulations and the requirements of the employers' liability insurance associations have also to be complied with.

Qualified Personnel

Mounting, initial operation and maintenance may only be performed by qualified persons.

Safety warning

Light barriers do not protect anybody from machine-caused flying objects. The AKAS® protects fingers and hands that hold the sheet during the operation. **Therefore it does not protect during any fast engagement between the bending punch and the matrix short time before those are closed.** The protection function of the system is cancelled when the Muting lamp is on. The front beams E3-E6 (AKAS®-3PM, AKAS®-3PF) which are turned to the operator before the bending line do not protect, if the box-bending function has been activated earlier. With the integration of a AKAS® safety system, the standard should be strictly complied with the European Standard (EN 12622). Protection circuits and Emergency can only stop the opening movement when the movement is interrupted with the RXOK outputs.

A-Test: putting into operation

The setting must be done in a way that the following test will be passed: !!! If either test A or B fails, the machine must not be used until the problem is resolved !!!



- The B-Test must be done for safety reasons each 5 times on the left end and on the right end of the upper tool.
- The press brake must be equipped completely with the heaviest upper tool.
- Start of the closing movement from the maximum top dead centre (T.D.C)

B-Test: daily check (at least every 24 hours)

At the beginning of each shift and after each change of tools, the AKAS® press brakes protection must be checked as follows (see also EN 12622): Test must be carried out at both left and right ends of the bending punch. The punch must not touch the step-shaped test rod.



- a.) Place the test piece in position "10" on the lower tool. Select the box bending function if you use a system of the AKAS®3... product family. Now start the close down movement.
- b.) The press brake stops.
- c.) The test piece must be placed in position "15" under the upper tool. In this position ("15") the test piece may not touch the upper tool.
- d.) Drive up the press brake. Place the the test piece in position "35" on the lower tool. Select the normal bending function if you use a system of the AKAS®3... product family. Now start the close down movement.
- e.) The press brake must be stopped in a way that the test piece ("35") may not touch the upper tool.
- f.) Turn on the sender (adjustment keyswitch to ON position) and move the test piece ("14") along the tip of the upper tool. The adjustment controll LED P1 on the AKAS® receiver has to remain ON during the test.

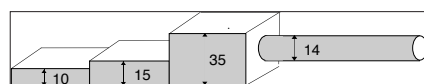

Fig.5/1

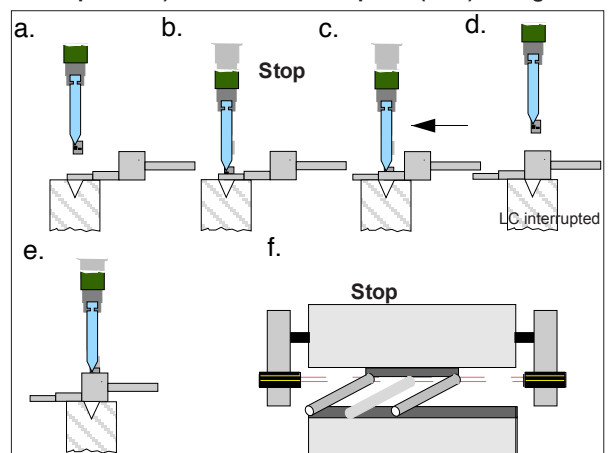

Fig.5/ 2

Prerequisites for using the press brake protection AKAS® 2.1

1. Use only tools with the same height in the same fixing on the press. All utilized tools must have one common bending line.

2. According EN 12622 the press brake safety system AKAS® is designed specifically and only for the use of "V" type tools.

3. Stoppers, which are mounted at the matrix, lead to a premature switching-off of the downward movement

4. The maximum allowable overrun traverse of the machine: 11mm / AKAS®-3P..

The press must have an automated overrun traverse control for the first stroke. If not, it can be realised by the AKAS®-3PF and a cam controller or by the Finessler AMS-system . Before the initial start-up, the overrun traverse must be checked either by using the test rod (see page 9) or by using an Overrun Traverse measuring device. (upon customer's request, Finessler Elektronik will perform the Overrun Traverse Measuring on the customer's machine.) **If one results of 10 consecutive measurements is larger than 11mm / AKAS®-3..., the fast speed must be reduced.**

5. Due to the missing sychronization during fast speed, AKAS® cannot be used for two machines aligned in parallel (e.g. "tandem press brake") .

6. Muting of AKAS.

During the slowspeed closing movent the control system of the machine must send the mute signal to the AKAS receiver. Please refer page 15 how to setup the correct blanking / mute point values .

The control system of the machine must reliably guarantee, according to safety category 4, that from this point the stroke speed is $\leq 10\text{mm} / \text{s}$.

6.1 **Bending boxes with AKAS** If the "boxbending" mode of AKAS is activated the blanking and the muting signal must be activated before the receiver element E2 (for Details see page 12) is interrupted. Please refer page 15 columns "boxmode" how to setup the correct blanking / mute point values for boxbending mode.

6.2 **Bending flat sheets with AKAS** Before the blanking signal is sent to the AKAS receiver any of the receiver elements E1 and E3 – E6 must not be interrupted by the sheet or the lateral die cover (for Details see on page 10)

But the receiver element E2 must be interrupted by the sheet or the lateral die cover.

The blanking signal can be a output signal from the machine NC.

The closing stroke can continue in high speed until the mute point is reached

7. The protection of a pressbrake by the AKAS® does not permit bending in the bottom of a box inside the box in fast speed.

8. **The AKAS® does not protect:**

-if the machine is only run in the work speed, or AKAS will be interrupted during fast speed and the stroke will be continued in work speed

-if the overrun traverse of the press brake is too long

-from squeezing during the bending operation

-if the mutinglamp is constantly on

-if the lateral stencil cover is higher than the top of the die ans the blanking signal (SP) is set to this wronh position of the lateral die cover.

See pic 6/3 together with a wrong SP setting

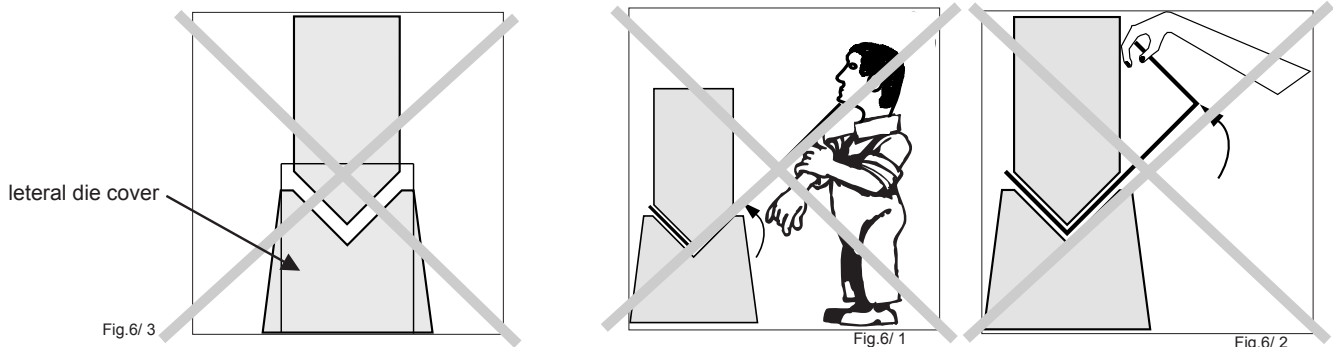

9. **The hazardous state of the machine must be terminated by the sensor function.**

10. **The safety level (class 4) of the accident preventing light barrier should at least correspond to the safety level of the control system of the machine.**

11. **Laser beams may be deviated due to air currents, this may cause unwanted and unforeseen machine stops. Therefore the machine must be erected at a place free of air currents.**

Acceptance Acceptance test: the installation acceptance test and inspections should be carried out by a competent person in possession of all the information supplied by the manufacturer of the machine and the ESPE.
 Upon customer's request, Fessler Elektronik will perform the initial acceptance as well as the annual test. Additionally, customer training seminars on how to execute annual tests will be conducted at regular intervals.

Annual Inspection The machine owner must make sure that a competent person is assigned to check the light barrier annually. This person can be an employee either from the light-barrier manufacturer or from the operator's staff. The annual test shall be executed according to the inspection *sheet on pae 49*.

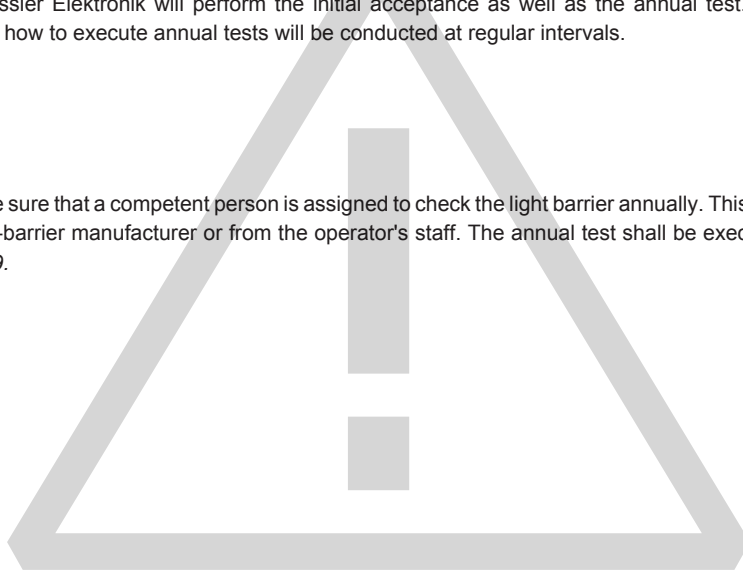

The laser - accident preventing light barrier AKAS® is an electro sensitive protective and controlling device (ESPE) which has the function to protect operators from accidents. This happens as follows : Before a part of the body is squeezed between two opposed moving machine parts, this part of the body interrupts at least one light beam. By this means the movement of the machine is stopped, before it comes to an injury.

AKAS®

- meets IEC 61496, Typ 4, prEN 12622
- is self- monitoring without additionally wiring.
- easy to adjust after tool changing.

Operative range for the laser-accident preventing light barrier of the AKAS® types are: **press brakes**

AKAS®-3PM / -3PF: equipped with electromotor driven supports for transmitter and receiver for self-acting tool change if tools with different heights are used (see fig. 8/1).

**with Support:
AKAS®-3P...**

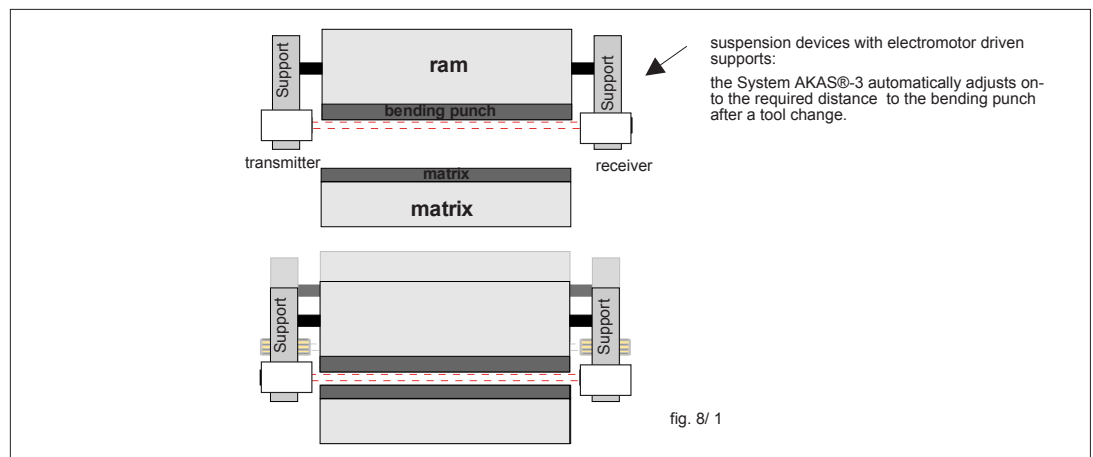

**Serial Numbers
AKAS®-3P...**

The serial numbers are located at the front side of the housings of both transmitter and receiver supports.

Functions / Characteristics	systems <u>without</u> operating mode selection operation only with additional safety PLC (e.g. FPSC)		systems <u>with</u> operating mode selection with integrated safety functions	
	AKAS®-3PM		AKAS®-3PF	
with / without Support self-adjusting onto different tool heights	with		with	
max. Overrun Traverse of the press brake	4 - 11 mm		4 - 11 mm	
recommended turnover point from fast speed into slow speed (according to overrun traverse of the press) Distance between metal sheet and bending punch)	0 - 6 mm		0 - 6 mm	
Detecting beams / Receiver elements	3 / 6		3 / 6	
Inputs				
Overruntraverse control NLW	-		1 -selectable with / without	
3 inputs for control of protection doors / emergency-OFF-circuit NA1, NA2, NA 3 for paired use 1 pair lateral door circuit, equivalent or antivalent, 1 pair rear door circuit, equivalent or antivalent, 1 pair emergency-OFF-circuit s	-		3 Pairs -selectable with / without	
Stop contactor control EDMO, EDMS	-		2 -selectable with / without	
data of traverse in slow speed SGW	-		1 -selectable with / without	
start / stop of closing stroke FUS, FOU		2 equivalent	2 -selectable antivalent or equivalent switching	
position control in slow speed SGO, SGS		2 equivalent	2 -selectable antivalent or equivalent switching - selectable with / without foot pedal delay	
selection of box bending KAST	1		1	
safety point SP	1		1	
Outputs				
Safety outputs for release of closing stroke OSSD1, OSSD2	2		2	
release and Emergency OFF of the rear stoppers RXOK1, RXOK2	-		2	
demand of a higher change-over point from fast speed into slow speed above the slug during box-bending HUSP	1		1	
box bending function is displayed HUSP	1		1	
output for messages RS 232 TXD	1		1	
demand for slow speed SGA	1		1	

bending of flat sheet metal

The V opening of the die must be covered with the lateral die cover. This is necessary because The receiver element E2 must be interrupted before the SP signal (blanking signal) is activated. The SP signal must be active before any of the receiver elements E1 or E3 – E6 is interrupted by the sheet or the lateral die cover. The machine can still move in high speed for a maximum of 800ms. After this time the machine must move in slowspeed ($\leq 10\text{mm/s}$).

At start of stroke

- If the SP signal is not active all receiver elements E1 – E6 must be free. During the following closing stroke only E1 and E3 – E6 must be free.
- If the SP signal is active the receiver element E2 must be interrupted. Attention, if SP is active but E2 is free, closing stroke is not possible (e.g. lateral die cover is missing or not in correct position)
- If the SP signal is active and at least receiver element E2 is interrupted, AKAS will turn off the SGA output (highspeed enable). Only a slowspeed stroke is allowed now.
- If the SP signal is not active and at least one of the receiver elements E1 or E3-E6 is interrupted (E2 does not matter now) it is possible to start a slowspeed stroke by pressing the footpedal two times. (SGA will turn off. E.g. for a bend inside a closed box)

fast speed

- If the SP signal is not activated the receiver elements E1 and E3-E6 must be free.
- If receiver element E2 is already interrupted and the SP signal is just activated, the receiver elements E3 and E4 must stay free for at least 27ms. (Important: E2 must be interrupted before SP is activated)
- If receiver element E2 is already interrupted and SP will be activated, the machine can continue to move in high-speed for up to 800ms. Before the 800ms are exceeded the machine must change to slowspeed. (Muting will only be activated in slowspeed)

Principle of function bending of flat sheet metal

1. Release the closing movement by activating the foot pedal. Receiver E1 to E6 are activated.
2. Press brake closes in **fast speed** ($> 10\text{mm/s}$)
Receiver element E2 are deactivated, **E1, E3 bis E6 activated (protection)**

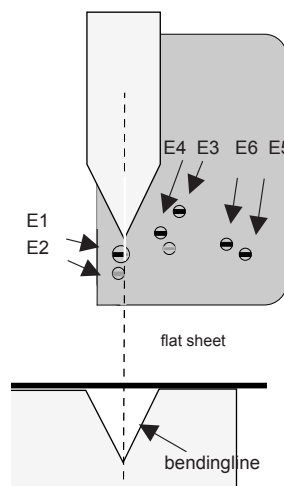

Fig.10/ 1

3. Position for AKAS blanking reached (SP signal is changing from SP = 0 to SP = 1):
The receiver elements E1, E5 and E6 will be muted. E4 will stay active for about 27ms (max allowed travel distance 4mm). E3 will stay active.
4. After reaching the change-over point from fast speed to **slow speed** ($= 10\text{ mm/s}$):
(Distance between punch and sheet 0-6mm depending on the stopping distance of the machine)
Receiver element E3 will be muted, so the complete AKAS receiver is muted now.
5. All receiver elements are muted and the muting lamp is on. The bending procedure is finished.
(The fast speed mode and the slow speed mode are limited of about 2 min.)

Advice The beams of the AKAS® must be located at a certain distance to the bending punch.
 (See **chapter 5.2 Overrun Traverse Measurement** and **chapter 5.8 Adjustment of the distance between the AKAS® and the bending punch**.
 Caution! Use only tools with equal overall height within one fixing.

Bending of wavy sheet metal **Closing movement with interrupted protective field**
 The AKAS® system offers the possibility to execute a closing movement under monitored slow speed even when the protective field is interrupted by a wavy sheet metal.
 After the interruption of the protective field and the release and reactivation of the foot pedal, the AKAS will deactivate the SGA output when the protective field is interrupted. By this, only slow speed will be enabled by the machine control (NC).
 AKAS® provides a reaction time of about 200ms for the machine control and then activated the safety switching outputs for the closing movement (OSSDs). The OSSDs remain activated as long as the AKAS® receives a slow speed message to SGS and SGO:
 by AKAS®...F within the next **70 ms** + the selected enhanced tolerance (see page 35/36)
 by AKAS®...M within the next **170 ms** (A tolerance enhancement is possible only with the AKAS®...F systems).

By twice pressing the foot pedal can also use this function to perform a stroke, when the protective field of the AKAS ® is interrupted in the OT.

Function principle box bending

see diagram page 56

1. "Box Bending" is activated by the box bending button. The signal at the box bending input KAST must be high (+24V) for at least 100 ms and after that low (0V) for at least 100 ms.
(The box bending function can be canceled by twice activating the box bending button again)
2. AKAS® confirms the selection of the box bending by activating the output HUSP and the LED *box-bending*

- HUSP output active: The speed change point (fast -> slow) must be a bigger value (refer table 15/1)
The receiver elements E3 – E6 are muted, **E1 and E2 are active.**

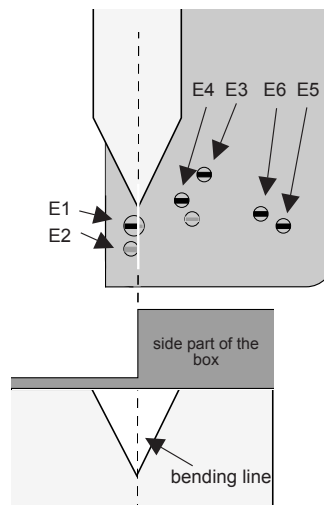

Fig.12/ 1

3. Release the closing movement by activating the foot pedal. The press closes in **fast speed (> 10mm/s)**.
4. After reaching the change-over point from fast speed to **slow speed (= 10 mm/s)** :
E2 is deactivated, **E1 remains activated for 0,5s (5mm) more (=protection)**
5. All Receiver elements are muted and the muting lamp is on. The bending procedure is finished.
(The fast speed mode and the slow speed mode are limited of about 2 min.)
6. After the bending procedure the box bending function is cancelled.

Bending of the box bottom

Closing movement with interrupted protective field

The AKAS® system offers the possibility to execute a closing movement under monitored slow speed even when the protective field is interrupted.

After the interruption of the protective field and the release and reactivation of the foot pedal, the AKAS will deactivate the SGA output when the protective field is interrupted. By this, only slow speed will be enabled by the machine control (NC).

AKAS® provides a reaction time of about 200ms for the machine control and then activated the safety switching outputs for the closing movement (OSSDs). The OSSDs remain activated as long as the AKAS® receives a slow speed message to SGS and SGO:

by AKAS®...F within the next **70 ms** + the selected enhanced tolerance (see page 36/37)

by AKAS®...M within the next **170 ms** (A tolerance enhancement is possible only with the AKAS®...F systems).

Bending of very small pieces

In the case of bending of very small pieces, which must be guided by the fingers, the **box-bending function must be selected. Otherwise, the fingers would interrupt E3, E4, E5, E6 (AKAS®-3P M/-F) which would lead to the switching off of the bending process!**

With activated box-bending function, a finger which is placed next to the slog on a large matrix, is not detected!!



housing type The aluminium housing of both transmitter and receiver are powder coated in RAL 1020 yellow. The optical head is made of acid-resistant spherically reinforced plastic (polyamide). The support housings are of eloxal coated aluminium.

fastening With Finessler tenon blocks

dimensions

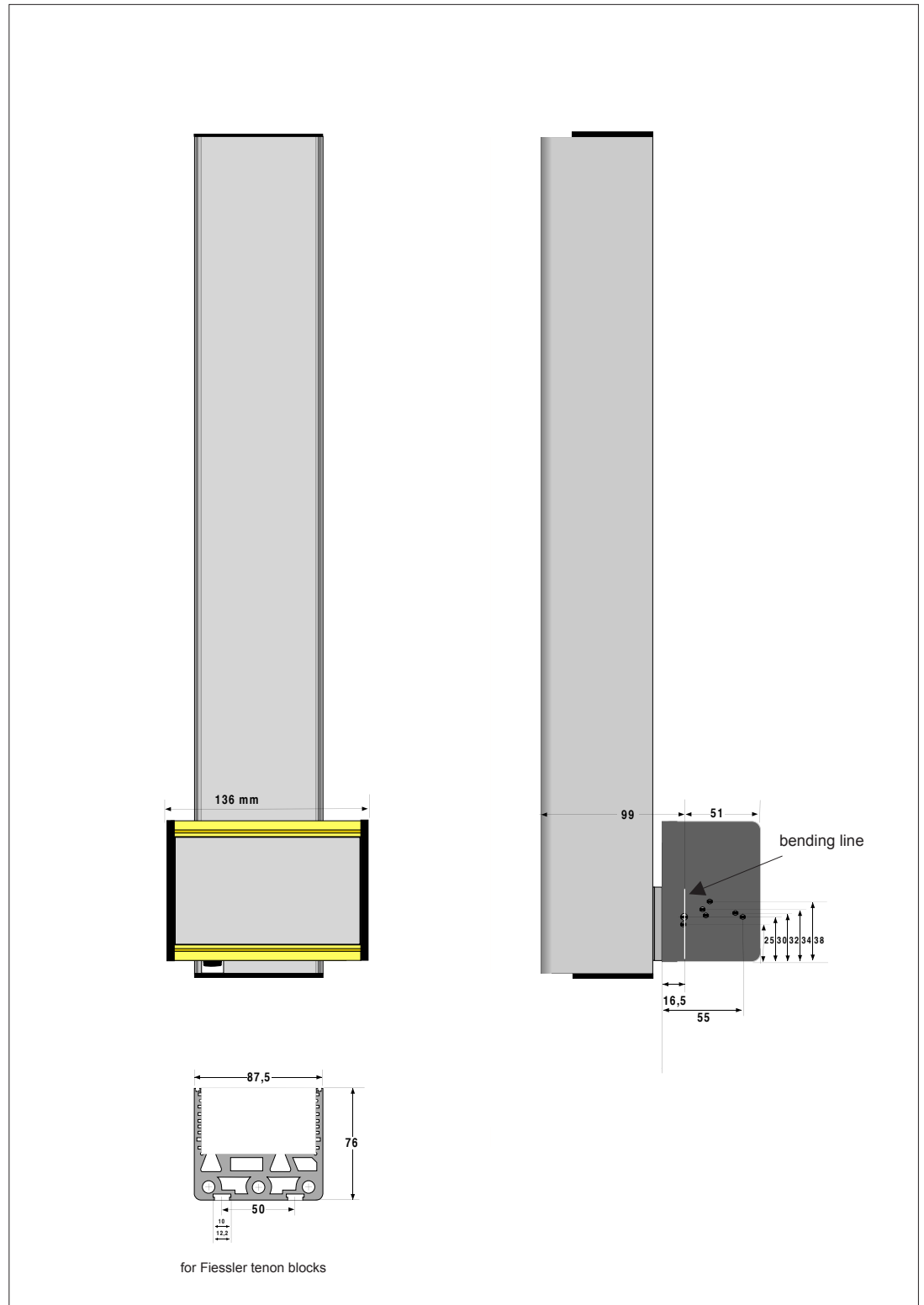

Fig. 13/1

max. Standard-Range
between transmitter/receiver unit

8 m

max. Upper tool length

6m

(For longer range please get in
contact with Finessler Elektronik or
your local dealer).

max. positioning range of the
supports

AKAS®-3...

Standard 150 mm

(190 mm as option)

(On demand, supports with larger
position ranges are available)

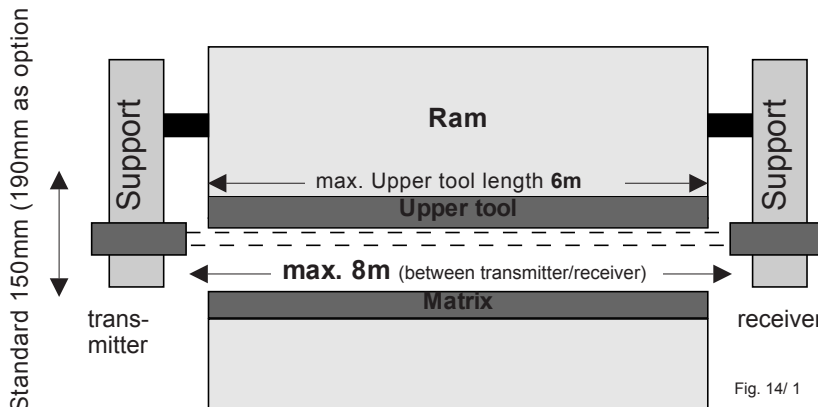

Fig. 14/ 1

Holder for AKAS®-3...

order code AKAS/AS/U (optional)

Finessler Holders



front view fig. 14/2

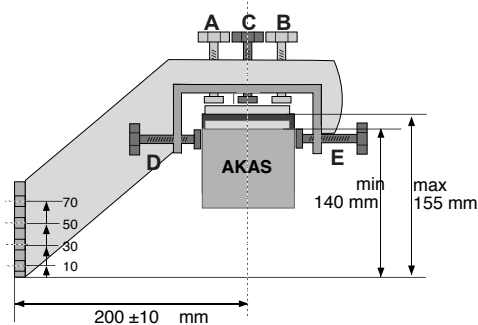

drawing, view from the top fig. 14/3



rear view fig. 14/4

swiveling adaptor for Holder AKAS/AS/U

order code AKAS/AS/U/S (optional)

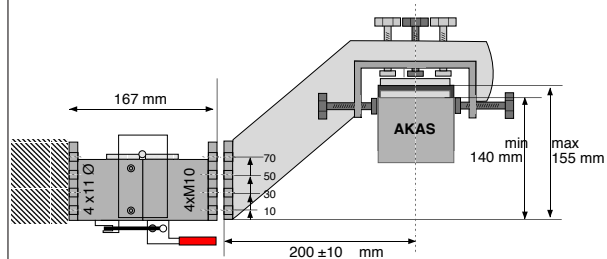

drawing, view from the top fig. 14/5

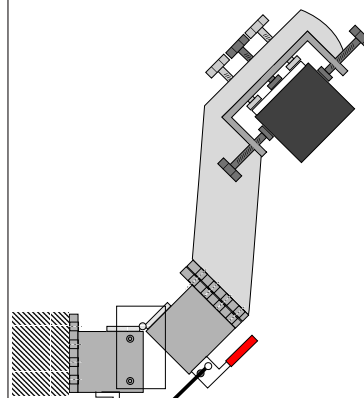

closed fig. 14/6



open fig. 14/7

How to proceed when mounting the AKAS® 5.1
Overrun Traverse Measurement / According dip switch adjustment 5.2

How to proceed: Step by step mounting the AKAS®

1	a. Overrun traverse measurement / b. Dip switch adjustment at the support
2	Design of the mechanical holders - void if Finessler holders are used
3	Mounting of the holders at the ram
4	Mounting of the AKAS® on the holders
5	Connection of the AKAS® / Selection of the operating mode at the ...F-series
6	Adjustment of the AKAS® during first installation
7	Adjustment of the distance of the AKAS® from the bending punch (self-acting if supports are used)
8	Function Verification of all electrical connections in view of the safety class 4 requirements
9	Self-acting Overrun Traverse Test

1a. Overrun Traverse Measurement



The press must have an automated overrun traverse control for the first stroke. If not, it can be realised by the AKAS®-...F and a cam controller or by the Finessler AMS-system . Before the initial start-up, the overrun traverse must be checked either by using the test rod (see page 9) or by using an Overrun Traverse measuring device. (upon customer's request, Finessler Elektronik will perform the Overrun Traverse Measuring on the customer's machine.) If the results of 10 consecutive measurements are larger than 11 mm (AKAS®-3P...), the fast speed must be reduced.

1b. adjustment of the dip switches only AKAS®-3...



According to the individual overrun traverses of each machine, 7 different distances Z (=gap between uppermost receiver element and bending punch, see Fig. 15/1 u. Fig. 15/2) can be programmed via 3 dis switches at the support. The adjustment to the respective selected distance is carried out automatically. (s. chapter 5.7 (Adjustment of the distance of the AKAS® from the bending punch). Finessler delivers the system pre-adjusted "B".

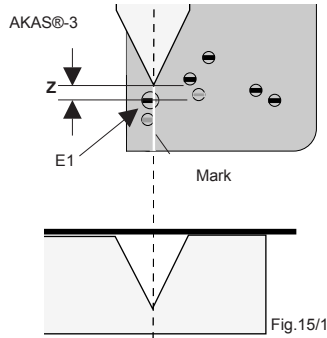

adjustment	distance Z after completed automatical adjustment in accordance to the max. allowable overrun traverse of the press brake after the interruption of the beams. AKAS®-3P...	Dip switch Position	recommended blanking point SP->1 above the slug surface AKAS®-3P...		recommended change-over point (V->10mm/s) from fast speed into slow speed* above the slug surface *AKAS®-3P...	
			flat (HUSP=0)	box (HUSP=1)	flat (HUSP=0)	box (HUSP=1)
	The distance must not be less than the stopping distance of the machine		flat (HUSP=0)	box (HUSP=1)	flat (HUSP=0)	box (HUSP=1)
B	11 mm	off on	14 mm	19 mm	6 mm	19 mm
C	9 mm	off on	12 mm	17 mm	4 mm	17 mm
D	8 mm	off on	11mm	16mm	3mm	16mm
E	7 mm	off on	10mm	15mm	0mm	15mm
F	6 mm	off on	9mm	14mm	0mm	14mm
G	5 mm	off on	8mm	13mm	0mm	13mm
H	4 mm	off on	7mm	12mm	0mm	12mm

table 15/1



The distance to the upper tool must be set so that the A-test with the test block is passed.

The adjustment A is not applicable for AKAS 3P.

* by this, a tolerance in sheet metal waviness of about 2mm is given.

2. design of the holders
void if Finessler holding Devices are used

- The dimensions of the self-supplied holders must be individually laid out according to the dimensions of the press brake.
- The self-supplied holders must be made of torsion-free rigid material, e.g. steel tubes 80 x 50 x 5 mm.
- They must be sufficiently long so that the largest and the shortest tool are still within the detection range of the AKAS®.
- If frequent tool change requires the presence of a swivable holder, this should be installed at the receiver arm, in order to leave the precise adjustment of the transmitter arm unchanged.

3. Mounting of the holders at the ram

- a) The holders must be mounted at the ram in a way that the marks on transmitter and receiver correspond exactly to the bending line. The receiver elements E5 (AKAS®3 fig. 20/3) must face the operator and E1 (AKAS®3 fig. 20/3) must remain free when the highest tool is utilized. (Fig. 16/ 2 u. /3)
- d) The lowest edge of both supports must be at the same level.
- c) The gap between the front edge of the AKAS®systems and the press brake should be > 100mm in order to prevent injuries while closing the press.
- d) The existing mechanical guards of the machine must be modified in a way that any by-passing of the safety equipment by the operator is not possible. Likewise, any danger of getting caught between grids and safety equipment must be excluded.

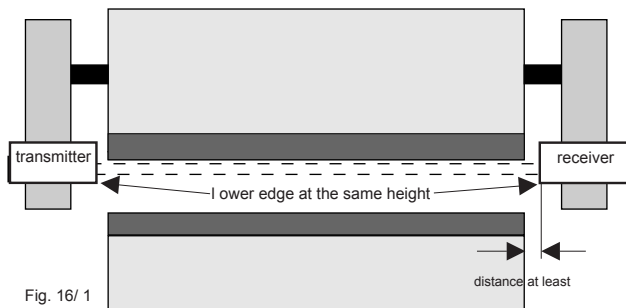
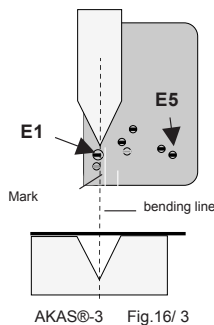

Fig. 16/ 1



Flange for fastening the item at the ram

Fiessler holder fig. 16/4



AKAS®-3 Fig.16/ 3

please observe! Transmitter and receiver of the AKAS® must not be subject to mechanical stress (e.g. bottles must not be placed on it). To prevent this and to protect the AKAS® from any damages, a solid protection cap should be always mounted. Make sure that no material or solid parts are placed in the clearance beneath the AKAS® and the holders, in order to exclude any collision caused by the closing movement of the press brake. Fig. 16/ 5

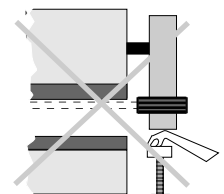
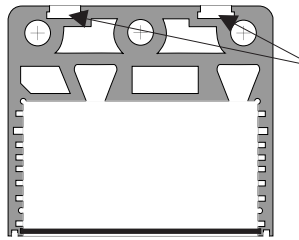

Fig.16/ 5

4. Mounting of the AKAS® on the holders
a) AKAS®-3...
 Fiessler holder

a) Support with tenon blocks at the rear



2 M5 s liding tenon blocks are located in each groove for fastening
 The adjustment is made with the help of the holders.

Fig. 17/ 1

Remove the fastening plate from the Fiessler holder and tightly fasten it by using the tenon blocks at the AKAS®.

Choose a mounting position according to the directions given in chapter 5.7 **Adjustment of the AKAS® during first installation.**

Pay attention to avoid any deformation of the profile.

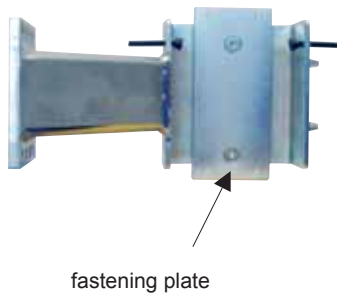

fastening plate

Fiessler holder front view fig. 17/2

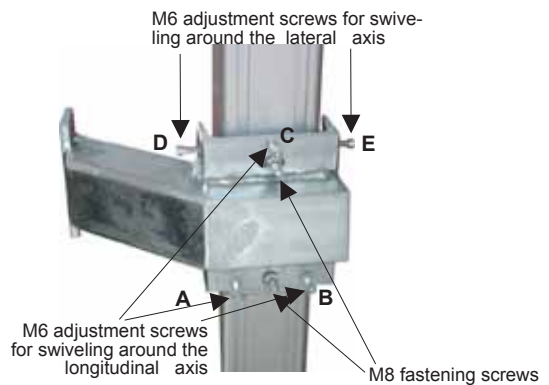

M6 adjustment screws for swiveling around the lateral axis

M6 adjustment screws for swiveling around the longitudinal axis

M8 fastening screws

Fiessler holder rear view fig. 17/3

Mounting on self-supplied holders

b) Support with fastening angles at the upper and lower side (as option)

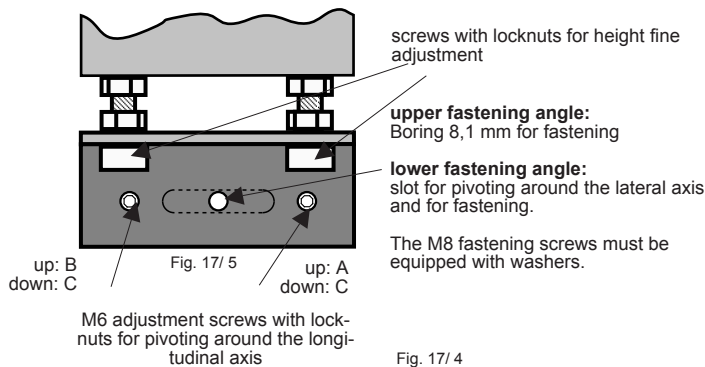

screws with locknuts for height fine adjustment

upper fastening angle:
 Boring 8,1 mm for fastening

lower fastening angle:
 slot for pivoting around the lateral axis and for fastening.

The M8 fastening screws must be equipped with washers.

up: B down: C Fig. 17/ 5 up: A down: C

M6 adjustment screws with locknuts for pivoting around the longitudinal axis

Fig. 17/ 4

To guarantee a trouble-free operation, the supports of both the receiver and the transmitter must be fixed at solid, deformation-free plane-parallel constructions at the ram.

The adjustment screws must be easily accessible. When pivoting around the longitudinal axis, the locknuts of the lower M 10 screw at the angle bracket should be unscrewed, the other M10 locknuts must be tightened.

Pay attention to avoid any deformation of the profile. By unscrewing the M10 screws, fine height adjustment is enabled.

6. Adjustment of the AKAS® at the first installation

-AKAS®-3...

- both supports must be mounted in a way that:
1. the highest (biggest) bending punch and the smallest bending punch is within the range of the supports.
 2. using the smallest bending punch, the receiver element E1+Z (AKAS®-3 see fig. 18/1) are covered by the punch at the highest range position of the support.
 3. using the highest bending punch, the receiver element E1+Z (AKAS®-3 see fig. 18/1) can still be positioned correctly at the lowest position

Transmitter and receiver must be mounted at the same height if both are installed in the lowest position of the supports.



Fig.18/1

The receiver and the transmitter must be swiveled around the longitudinal axis in a way that their housings are plane parallel to the ram. With pivoting around the longitudinal axis, the adjustment screw or the locknut that counteracts the screwing movements, must be loosened.

adjustment of the receiver

Adjust the support with the help of a spirit level vertically, i.e. parallel to the guiding rails of the ram.

Set up the receiver with the M6 adjustment screws until the white line on the receiver cover is in line with the bending line of the machine.

Verify that the white line on the receiver is in line with the bending line all over the entire movement range of the receiver support.

Check this over during the whole travel of the support of the receiver by turning the key-operated switch to "ON" and carrying the receiver upwards with pressing the button "RECEIVER UP". For doing this, the adjustment mode must be in manual mode (s. chap. 5.8.). During the upward movement of the receiver, repeatedly turn the key-operated switch to "OUT" and check the distance between the mark and the perpendicular (bending line) to make sure that the receiver is carried up parallelly to the bending line. The displacement by the motor is not intended for nonstop carrying up and down. In this case the thermal protection switches off the motors. After letting go the button and a short brake you may continue the carrying procedure.

adjustment of the transmitter

Set up the transmitter with the M6 adjustment screws until the white line on the transmitter cover is in line with the bending line of the machine.

Verify that the white line on the transmitter is in line with the bending line all over the entire movement range of the transmitter support.

The red transmitting beams should meet the receiver like it is shown in the opposite illustration. When doing so, please observe that the receiver stays in the lower stop of the support. To check this, cover the transmitter entirely. Then the receiver should not move further downwards. The adjustment mode must be in manual mode (s. chap.5.8.)

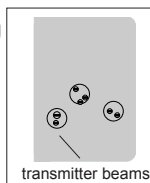

AKAS®-3 Fig.18/3

fine adjustment

-AKAS®-3...

The support of the transmitter must be turned around both the longitudinal and vertical axis until the laser beams are aligned parallel to the ram.

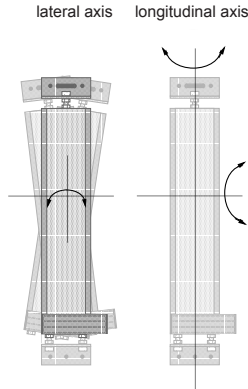

angular fastening: When turning around the longitudinal axis the lock nut of the single M10 screw which is located at the angle must be loosened. (Otherwise there is a danger of deformation of the support housing!)
For checking whether the laser beams are parallel to the ram, a tool may be clamped alternately in front of the transmitter and the receiver (Fig. 19/5).

The transmitter is moved upwards to the ram until the tip of the ram covers a small segment of the highest transmitting beam (Fig. 19/3). This will be in the 10'clock position. When moving the AKAS® for the first mounting, the manual mode has to be selected

If the tool is mounted completely on the left or on the right hand side, there must be always the same projection (Fig. 19/3) on a sheet of paper held behind the tool (Fig. 19/5).

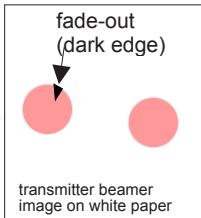

This check must be done with the highest (biggest) and lowest (smallest) tool.

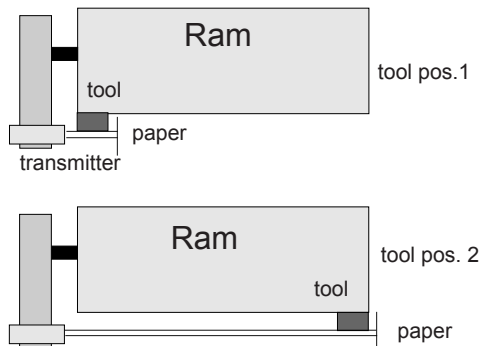

Fig. 19/5

Then, the transmitter is carried upwards by pressing the button "transmitter up/down". This action makes the receiver follow.

When the highest position is reached, please check whether the receiver is also free and whether the transmitting beams meet the receiver as shown in Fig. 19/3. By this it is guaranteed that both transmitter and receiver move parallel to each other and to the bending line.



It is important to note that the marker line is only a rough guide. After the coarse adjustment is finished please activate the box bending mode and do the following tests:

- a) an object which protrudes 3mm beyond the bending line into the machine must be detected
- b) an object which protrudes 2mm beyond the bending line into the machine must not be detected

If a) is not met, the transmitter and receiver must be adjusted further forward towards the operator.

If b) is not met, the transmitter and receiver must be adjusted further backward, away from the operator.

Adjustment of the AKAS® at the first installation 5.7 correction of adjustment errors

Dejustage possibility	remedy
AKAS®-3P...	AKAS®-3P...
Position of dark (=covered) section is not in 1 o'clock position but 12 o'clock or earlier.	By unscrewing all M6 adjustment screws that are responsible for the longitudinal adjustment, (A,B,C) the support must be positioned further away behind the bending line.
Position of dark section is not in 1 o'clock position but 2 o'clock or later.	By tightening all M6 adjustment screws that are responsible for the longitudinal adjustment, (A,B,C) the support must be put closer to the bending line.
If the position of dark section is not located in 1 o'clock position but earlier when using the lowest tool, and if it is in the 1 o'clock position when using the highest tool, the support stands too close to the bending line.	By unscrewing the upper M6 adjustment screws that are responsible for the longitudinal adjustment, (A,B,C) the support must be positioned further away behind the bending line.
If the position of dark section is not located in 1 o'clock position but later when using the lowest tool, and if it is in the 1 o'clock position when using the highest tool, the support is too far away from the bending line.	By tightening the lower M6 adjustment screws that are responsible for the longitudinal adjustment the support must be put closer to the bending line.
In the left tool position the dark section is bigger than in the right tool position = case B Fig. 20/1	The support of the transmitter must be swiveled to the right in the slot.
In the left tool position the dark section is smaller than in the right position = case C Fig. 20/1 .	The support of the transmitter must be swiveled to the left in the slot.
In the left tool position the dark section is located in the 1 o'clock position, in the right tool position in an earlier position.	After unscrewing the M6 adjustment screws B and after readjusting the upper right M6 adjustment screws A, the support must be swiveled clockwise around its longitudinal axis.
In the left tool position the dark section lies in the 1 o'clock position, in the right tool position in an earlier position.	After unscrewing the upper left M6 adjustment screw A and after readjusting the M6 adjustment screws B the support must be swiveled counterclockwise.

correct transmitter adjustment

in correct transmitter adjustment

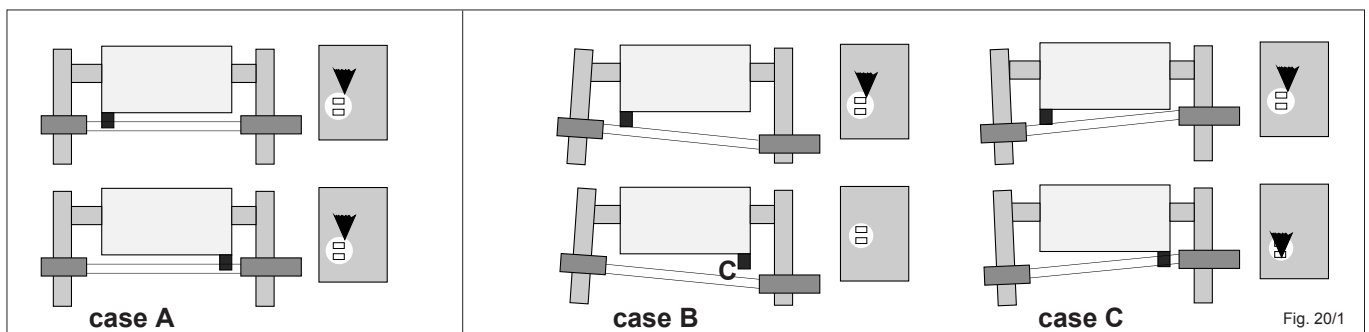
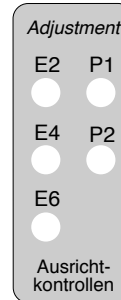

Fig. 20/1

AKAS®-3...

adjustment control
- LEDs

synchronization transmitter - receiver	AKAS®-3...
transmitter-beam does focus at all	E...on P...off
transmitter-beam does <u>not</u> focus precisely	E...partially off P...partially on
transmitter-beam does <u>not</u> focus at all	E...off P...on



Advise!
AKAS®-3PF: E2, E4, E6

LEDs are flashing slowly about once per second: Press has successfully stopped at the cam during the overrun traverse test, only when the cam is free again, the OSSDs can be enabled again. The adjustment control-LEDs are flashing slowly until the press brake is not opened completely.

adjustment directions



You will find these adjustment directions also on the front plate of the receiver support!

The magnetic lamina has to be placed as close as possible to the receiver side! Like displayed on the magnetic lamina.



Schematic layout of the AKAS®-II after a tool change-over and of the consecutive follow-up of the transmitter and the receiver.

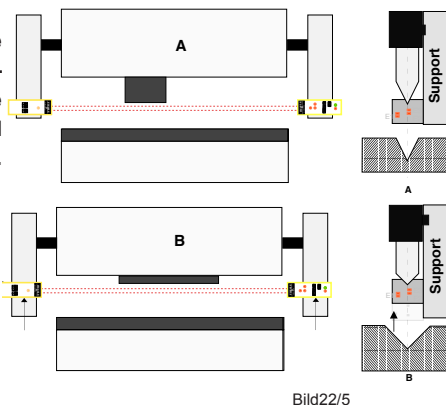

1. For the **first adjustment** or after a **tool change** the **key operated switch** at the support of the receiver must be turned to "ON", if the foot pedal is not activated.
2. Attach the **yellow** magnetic lamina vertical at the bending punch so that its edge is even with the bending punch. A correct adjustment is **only possible** if the magnetic lamina is even with the bending punch, as shown in fig. 22/3.

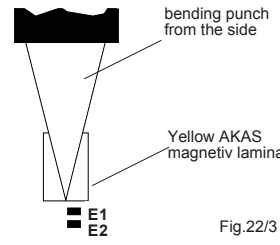
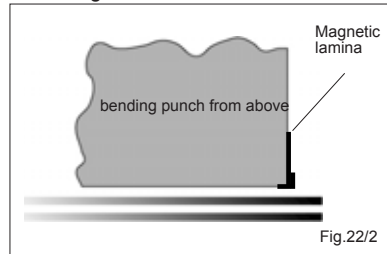

AKAS®-3P...

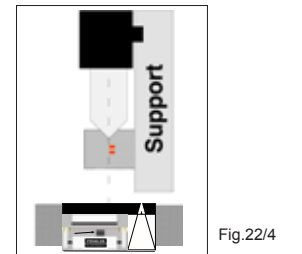
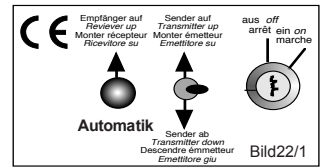

After having successfully adjusted the AKAS® system, place the bigger magnetic lamina at the side of the matrix (as shown in fig. 22/4) in order to cover it. It must be attached in a way that its edge is even with the matrix surface.

During the whole operation, the magnetic lamina must remain at the side of the matrix in order to cover it.

3. Now, the operator may choose from 2 different adjustment modes:

A. Automatic adjustment (Automatic Mode):

By pushing **ONCE** the button "**Automatik**" this adjustment mode is started. The procedure is automatically stopped as soon as the AKAS® system has reached the correct distance beneath the bending punch. The automated adjustment procedure can be interrupted, if - during the downward movement of both the AKAS®-transmitter and the AKAS®-receiver - the **switch =transmitter up** is activated. (This action will be of help primarily in the case of a large tool being exchanged by a considerably smaller tool.) By doing this, the downward movement of the transmitter and receiver towards the lowest point is prevented or stopped. If the transmitting light beam hits the receiver elements, i.e. the optics of both components are "locked into one another" (focussing), the AKAS® system will adjust itself automatically onto the exchanged tool newly fixed at the ram. If the light beam from the transmitter does not hit the receiver (i.e. the transmitter beams are interrupted by the newly mounted tool), both transmitter and receiver will move downward to the lowest point of the displacing range. When moving upwards again, they are searching the lower edge of the bending punch. The system will automatically adjust itself to the newly installed bending punch.

After having carried out this, the key at the **key-operated switch** is turned to "OFF" and the key is removed from its lock.

After having completed the adjustment procedure, the tests (see page 9) must be carried out. If the key of the key-operated switch is removed from its lock, the outputs of the system are free only if the "Automated Mode" has been completely terminated.

B. Adjusting by hand (Manual Mode):

By activating the button "transmitter down" the manual adjustment mode is started. Now the operator must check if either the transmitter beam hits the receiver - adjustment indicators P do not light up (see **B1**) - or if the transmitter beam does not hit the receiver - adjustment indicators P light up (see **B2**)

B1: (This function is required during the first adjusting of the system)

AKAS®-II-transmitter and AKAS®-receiver can be carried upwards or downwards by activating the switch "transmitter up / down". This is to verify whether both transmitter and receiver are correctly mounted parallel to the bending line of the machine. By activating the "Automatik"-button, the operator may start the automated adjusting procedure.

B2: (This function is carried out if the transmitter beam does NOT hit the receiver, p.e. if high matrixes are used)

By activating the "**Automatik**"-button or the "**receiver up**"-button, the receiver is carried upwards. At the same time, the transmitter can be carried upwards by activating the switch = "transmitter up/down". As soon as the transmitter beam hits the receiver again - adjustment indicators P are out at the receiver-, the adjusting procedure can be terminated as described in the automated adjustment "Automatic Mode" A.).

If the key of the key-operated switch is removed from its lock, the outputs of the system are free only if the "Automated Mode" has been completely terminated. The key switch

must not be turned, if the foot pedal is activated. The key must be kept under the control of a responsible person (set-up man)!

8. Verification of all electrical connections referring to safety class 4

see chapter 6 **Electrical connections**

9. Automatic overrun traverse test

According to prEN 12622, the overrun traverse of the machine must be verified automatically at the first stroke after its connection to power of the press brake or of the AKAS® and it must be repeated at least after 30 h, if the machine remains connected to power for a longer period of time.

The products of the **AKAS®-...F** product family can execute this overrun traverse test with the help of a cam switch and a normally closed contact. For this, the length of the cam must correspond to the allowable overrun traverse plus the hysteresis of the cam switch. The maximum allowable overrun traverse must not exceed the value programmed via the dip switch positions in the support of the **AKAS®-3PF**.

This overrun traverse cam must be mounted in a way that the press is in the maximum closing speed when the cam switch is opened by the cam, and the stroke is started out of the upper dead center of the machine.

The overrun traverse test is carried out after every voltage reset and must be repeated every 24 hours. After the successful overrun traverse test, the press must be at first opened for the execution of one bending stroke. The adjustment control-LEDs are flashing slowly until the press brake is not opened completely.

If the overrun traverse is too long, the cam does not open the overrun traverse cam switch when the closing movement is stopped, and the AKAS will prevent the complete bending stroke in fast speed.

If the overrun traverse control is not carried out by the AKAS®, the machine control must carry out an overrun traverse test at least after a voltage reset. This overrun traverse test must be repeated within the next 30 hours.

Electrical data

Safety Category	4 (EN ISO 13849-1:2008) and EN 61496 or IEC 61496 and prEN 12622
Performance Level	PL e (EN ISO 13849-1:2008), $MTTF_D > 300$
Safety Integrity Level	SIL3 (EN 62061:2005), PFH = $2,38 \times 10^{-10}$ /h
operation voltage	24 V DC, +/- 20 %, SELV
max. power consumption	(no charge): max. 2,0 A, AKAS...LC: 0,5 A
protection from incorrect connection	Protection against all possibilities of errors is not provided.
protection class	III
electrical connection	transmitter: AKAS®-3P... : plug-in connector with PG 9 as strain relief receiver: integrated plug-in connector with M 32 as strain relief
connecting cables	transmitter: AKAS®-3P... : 5-core, max. 1,5 mm, receiver: AKAS®-3P... : 10- to 28-core (according to operating mode) max. 1,5 mm
cable arrangement	Cables to be laid separately from high-voltage cables. The cable laying must be arranged in a way that no mechanical damage of the cable is possible. For that reason the cable must be installed in a reinforced hose if not protected by the machine.
outputs	OSSD 1 and 2 : Fail-Safe PNP outputs, max. 0,5A, with short-cut and side-current monitoring. Output current for resistance u. Inductive loads in the on state = min. 0mA, max. 0.5 A, max. Output current in the inactive = 50 uA max. Voltage in the inactive = 0.9V, max. capacitive load = 200 nF, max. Cable resistance between OSSD and load = 10 Ohm RXOK1 and 2 : PNP-outputs with short-cut and side-current monitoring during switching on, max. 0,5 A SGA, HUSP, SEU2K, KAST (KAST: only when using the external muting lamp): PNP-outputs max. 0,5A TXD : RS 232 serial interface
inputs	FUO, FUS, SGO, SGS, SP, EDMO, EDMS, NA1, NA2, NA3, NLW: 0 V / 24V DC +/- 20 %, 10 mA KAST: : 0 V / 24V DC +/- 20 %, 25 mA
response times	1,5 ms between the interruption of a light beam and the disabling of the OSSDs 10 ms between the release of the foot pedal or the opening of a protective circuit and the disabling of the OSSDs 10 ms between the opening of a protective circuit and disabling of the release of the rear stoppers RXOK1 & -2 2,6 ms between the opening of the overrun traverse cam switch and the disabling of the OSSDs during the overrun traverse test
time windows for the input signals (basic tolerances)	switch-over from stopped state into closing state after enabling of the OSSDs : 300 ms (only with operating mode with contactor/valve control EDM). switch-over into slow speed state when the start is carried out within the range of the safety point (at SP = 1): 100 ms after detection of the closing movement state by the EDM, i.e. 100 ms after enabling of the OSSDs when the press is operating without the EDM. switch-over into fast speed when the start of the press is outside the range of the safety point (at SP = 0): 100 ms after detection of the closing movement state by the EDM, i.e. 100 ms after enabling of the OSSDs when the press is operating without the EDM. switch-over into slow speed state when the start of the press with slow speed request (200 ms after SGA = 0 has been transmitted to NC): 70 ms after detection of the closing movement state by the EDM, i.e. 70 ms after enabling of the OSSDs when the press is operating without the EDM.
Tolerance enhancement	only with AKAS®-...F : max. 300 ms
environmental data	
ambient operation temp.	0° to 50° C
storage temperature	-25° to 70° C



Caution!! The use of both AKAS® ...**without F** series and the AKAS®...**with F** series adjusted to "operation with connection to an additional safety PLC" receiver is only permitted in combination with an additional safety PLC (e.g. **FPSC**) which provides the safe fast speed-/slow speed signals and closing request signals via cables with short-cut and side-current monitoring and which provides a safe processing of the OSSD-Signals of the AKAS®.



Caution!!! Only if the accident preventing light barrier AKAS® has been installed according to the operating instructions and connected according to the wiring diagrams, and if all relevant national and international accident prevention/safety regulations are observed, a safe operation is ensured!

Any modification of the specified circuits can cause hazardous states and is therefore forbidden.

If the press does not possess any position-monitored contactors for the switch-over from fast speed into slow speed, a safe integration is possible using the Fessler **AMS-System**.

Muting signal



Muting signal from the machine control system:

(Mutingsignal available from the contactor position control of the working stroke valve, from the pressure switch or from the AMS)

The muting signal out of the machine control must be laid out in a way that no muting signal is given to AKAS® if there is any malfunction of the involved switching elements (i.e. no release of a contactor or no switching over from fast motion into working motion) !

The top of the lateral die cover must be on the same height as top of the die.

set up operation



The set up operation has to be carried out according to the description in chapter 6.5.1 function 7 on the AKAS ...F systems, or the AKAS® must be switched off, the safety outputs of the AKAS® (OSSDs) must be muted, and the fast speed closing speed must be reliably excluded.

After the set up operation it must be made sure that this special muting of the OSSDs is cancelled.

Checklist

		OK
1	AKAS® is used on "foot operated fast motion" mode.	
2	"Foot operated fast motion" should only be possible with activated AKAS®	
3	During foot operated motion with AKAS®, the downward movement should only happen by pressing the foot pedal . (The above-mentioned foot switch, must be a 3 position safety foot switch.)	
4	The valves relevant for the downward movement must be triggered as directly as possible by the Fail-Safe PNP outputs OSSD1 and OSSD2 to keep the overrun traverse as short as possible	
5	For all operation modes without AKAS® protection, the safety system AKAS® has to be powered off (no active LED's on the AKAS receiver)	
6	The machine control system issues a muting signal with AKAS®-3...: value according the table 15/1 above the slug. (Mutingsignal coming from the contactor position control of the working stroke valve, from the pressure switch or from the AMS)	
7	In the flatbend mode the machines NC is activating the blankingsignal (SP). See table 15/1.	
8	The top of the lateral die cover is on the same height as the top of the die.	
9	At the AKAS®-3... system, the machine control system is in a position to carry out 2 different switch-over points from fast speed into slow speed for the bending of plane metal sheets or for the bending of box-shaped products . The selection of the respective switch-over points is realized by a static signal issued by the AKAS®. (HUSP)	
10	The machine control system prevents the fast speed during the closing movement if no static signal is given (SGA). This function of the press must not be necessarily safety-orientated.	
11	When the muting signal is given, it must be guaranteed according to safety class 4 that the stroke of the machine is < 10mm/s.	
12	The box-bending function must be chosen and acknowledged by a button (change-over contact). Here a pedal is more advantageous, because by using it both hands stay free to hold the sheet.	
13	After a voltage reset, an overrun traverse test is carried out.	
14	The overrun traverse is smaller than the value indicated in table 15/1 for AKAS®-3....	

- function**
- protection of the operator from being squeezed between the ram and the matrix (all other safety monitoring functions are carried out by a safety control (e.g. safety PLC FPSC))
 - The **safety PLC** gives a safe signal to the **AKAS®** inputs **FUS** and **FUO**, if a closing movement is about to be performed, and another **safe signal** is given to **SGO**, **SGS** and **SP**, if the press closes safely at slow speed.
 - For this, the signal lines **must be monitored for** eventual short-circuits by the **safety PLC**.
 - The safety PLC evaluates the safety outputs OSSD1 and OSSD2 of the AKAS® and stops the closing movement, if there is no signal from the OSSDs.
 - The machine control system must carry out an overrun traverse test of the press at least after every voltage reset, and this test must be repeated at least within the next 30 h. By doing this, the overrun traverse must not exceed the value of the maximum allowable overrun traverse that has been programmed by the dip-switches in the receiver-support (**AKAS®-3PM**).

terminals
receiver

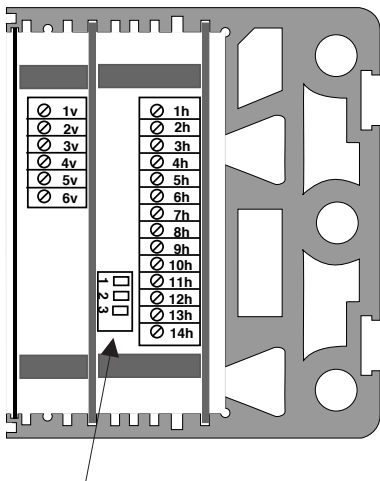

Dip-switches for the adjustment of the AKAS® in relation to the distance to the ram of the press (adjustment independent from the overrun traverse of the press according to the table 15/1)

transmitter

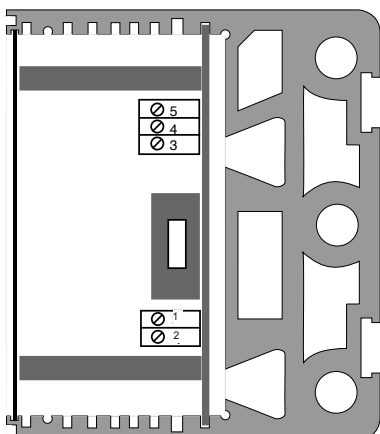

Terminals at the Receiver			
No	designation	meaning	signal level
1v	SGO	input slow speed position	0V at fast speed +24V at slow speed inputs switching equivalent
2v	SGS	input slow speed position	0V at fast speed +24V at slow speed
3v	SP	input safety point	0V in fast speed range +24V in blanking range
4v	SGA	output slow speed request	0V only slow speed permitted +24V fast-/slow speed possible
5v	HUSP	output higher mutepoint request (AKAS®-3M), message box bending	+24V if box-bending is selected
6v	-	nc	
1h	+Motor	connection for + motor transmitter support	
2h	-Motor	connection for - motor transmitter support	
3h	+Ub transmitter	connection for +Ub AKAS-connector	+24V if FUS is triggered
4h	FUS	input Start / Stop closing stroke	0V Press brake stop +24V Press brake close inputs switching equivalent
5h	FUO	input Start / Stop closing stroke	0V Press brake stop +24V Press brake close inputs switching equivalent
6h	KAST	input box bending	+24V Pulse minimum 100 ms
7h	OSSD1	safety output release of closing stroke	+24V if released
8h	OSSD2	safety output release of closing stroke	+24V if released
9h	+Ub 24VDC	power supply voltage	
10h	-Ub 0V	power supply voltage	
11h	-Ub transmitter	connection for -Ub AKAS transmitter	
12h	RS 232 GND	output message (State-/error)	
13h	RS 232 out	output message (State-/error)	
14h	earth	functional ground	

Terminals at the Transmitter		
No	designation	meaning
5	earth	functional ground
4	-S	-Ub transmitter
3	+S	+Ub transmitter
1	+Motor	+ Motor transmitter support
2	-Motor	- Motor transmitter support

AKAS®-3PM -operation only with additional safety PLC (e.g.FPSC)

6.3

AKAS®-3PF -with HEX switch position 00 00

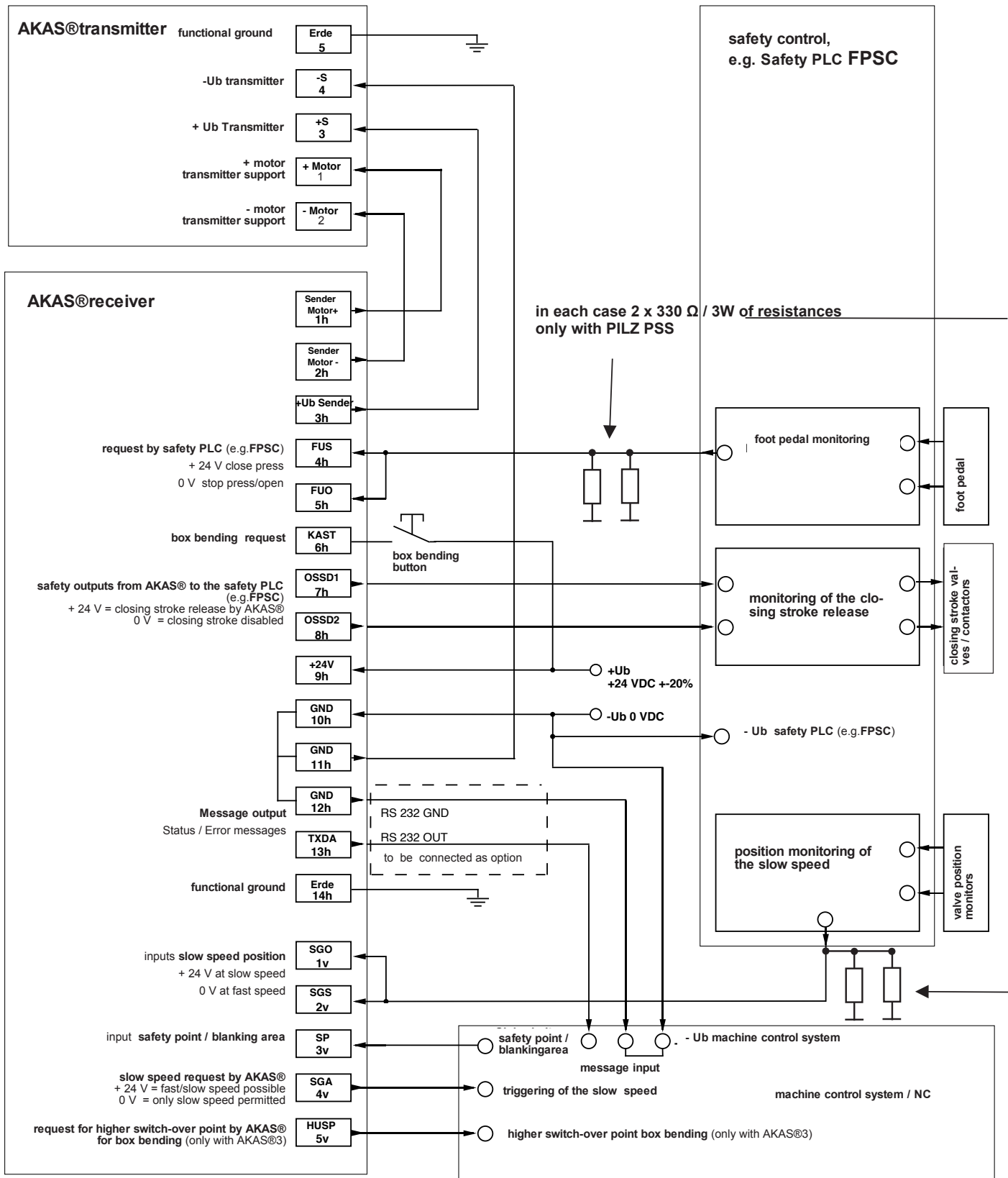

wiring diagram 1/S.27

functions **AKAS®-3PF** provide - apart from the standard functions - more safety functions which enable the monitoring and control of a press brake without additional safety PLC.
These safety functions are selectable via 4 HEX switches.

- **Protection of the operator from** being squeezed between the ram and the matrix
- **Overrun traverse test** (after every voltage reset, and to be repeated at least within the next 30 h)
- **Stop contactor control** (EDM)
- **monitoring of the slow speed position** (position monitoring of the contactors)
- **monitoring of the foot pedal** (inputs Start / Stop closing stroke)
- **Release of the closing stroke** (via safety outputs)
- **monitoring of the mechanical protective grids** (at the rear and at the sides of the press)
- **emergency-OFF-Monitoring** (Emergency OFF at the rear and at the front)
- **Emergency OFF of the rear stoppers** (Emergency OFF at the rear and at the front, protective grids)

Terminals
AKAS®-3PF
receiver

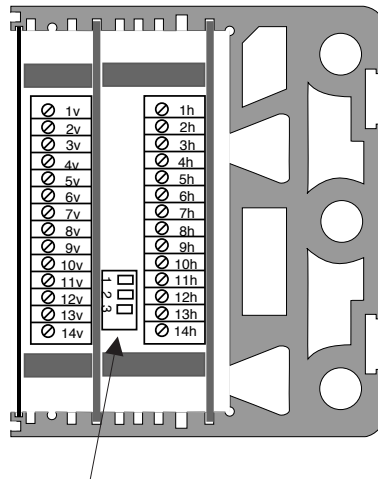

Dip-switches for the adjustment of the AKAS® in relation to the distance to the ram of the press (adjustment independent from the overrun traverse of the press according to the table 15/1)

transmitter

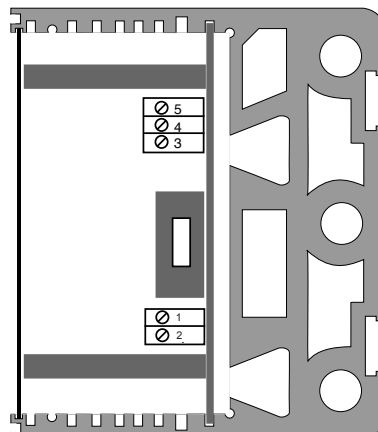

Terminals of the Receiver AKAS®-3F / -IIF			example for operation mode B8 B8 or F8 F8	example for operation mode 00 00
No	designation	meaning	signal level	signal level
1v	SGO	input monitoring of slow speed position	+24V at fast speed 0V at slow speed	0V at fast speed +24V at slow speed
2v	SGS	input monitoring of slow speed position	0V at fast speed +24V at slow speed	0V at fast speed +24V at slow speed
3v	SP	input safety point	0V: within fast speed range +24 V: within blanking range	0V: within fast speed range +24 V: within blanking range
4v	SGA	output request for slow speed	0V only slow speed permitted +24V fast-/slow speed possible	0V only slow speed permitted +24V fast-/slow speed possible
5v	HUSP	output higher mute point request (AKAS®3F), message box bending (AKAS®-IIF)	+24V if box-bending is selected	+24V: if box-bending is selected
6v	S_EU2K	+Ub transmitter EU2K 500/2- rear guard with antivalent switching light grid		
7v	NLW	input overrun traverse control input	0V: if activated by cam switch + 24V if not activated by cam switch	
8v	EDMO	input monitoring of the Stop valves	0V at closing stroke +24V at stop	
9v	EDMS	input monitoring of the Stop valves	0V: at stop +24V at closing stroke in fast speed	
10v	NA1	input Emergency OFF / rear metal grid	+24V if grid is closed i.e. emergency OFF is not activated	
11v	NA2	input rear / lateral metal grid	+24V if grids are closed	
12v	NA 3	input Emergency OFF / lateral metal grid	+24V if grid is closed i.e. emergency OFF is not activated	
13v	RXOK1	output drive rear stoppers Emerg. OFF	+24V if enabled	
14v	RXOK2	output drive rear stoppers Emerg. OFF	+24V if enabled	
1h	+Motor	connector for + Motor transmitter support		
2h	-Motor	connector für - Motor transmitter support		
3h	+Ub transmitter	connection for +Ub AKAS transmitter	+24V if foot pedal or key switch is activated	+24V if FUS is triggered or if key switch is activated
4h	FUS	input Start / Stop closing stroke	0V Press stop +24V Press close	0V Press stop +24V Press close
5h	FUO	input Start / Stop closing stroke	+24V Press stop 0V Press close	0V Press stop +24V Press close
6h	KAST / SGW	input box bending / Slow speed traverse information	box bend.: +24V pulse min. 100ms SGW: +24V if completely muting	+24V pulse min. 100 ms
7h	OSSD1	safety output release of closing stroke	+24V if released	+24V if released
8h	OSSD2	safety output release of closing stroke	+24V if released	+24V if released
9h	+Ub 24VDC	power supply		
10h	-Ub 0V	power supply		
11h	-Ub Sender	connection for -Ub AKAS-transmitter		
12h	RS 232 GND	message output (State-/error)		
13h	RS 232 out	message output (State-/error)		
14h	earth	functional ground		

Terminals of the transmitter		
No	designation	meaning
5	earth	Functional ground
4	-S	-Ub transmitter
3	+S	+Ub transmitter
1	+Motor	+ Motor transmitter support
2	-Motor	- Motor transmitter support

Use the grey marked connections depending on ceased type (see p.36/37)

Machine-Safety monitoring by AKAS®-3PF

Wiring example with a suitable hydraulics. AKAS is responsible for all safety related monitoring tasks (at a Hex switch B8 B8 or F8 F8)

AKAS monitors both positions of the fast speed and slow speed state and requires:
 in **fast speed:** at SGO = + 24 V and at SGS = 0 V
 in **slow speed:** at SGO = 0 V and at SGS = + 24 V
 During the switching over from one state into the other state, an enhancable switch-over time is tolerated. see **selectable switch-over delay enhancement of the valve position monitor**

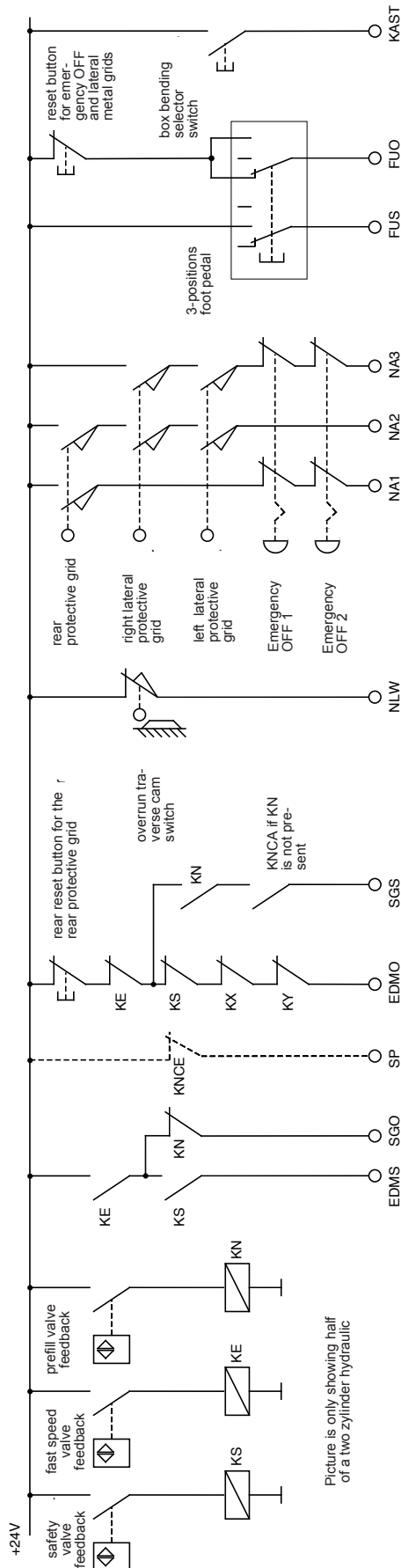

Picture is only showing half of a two cylinder hydraulic

Press brake	safety factor / KS	fast speed valve / KE	feeder contactor / KN
Stop	0	0	0
fast / down	1	1	0
slow / down	1	0	1
up	0	0	0

○ AKAS inputs

⊗ AKAS outputs

----- can be carried out by the NC or by a contact of the slow speed/fast speed switching over

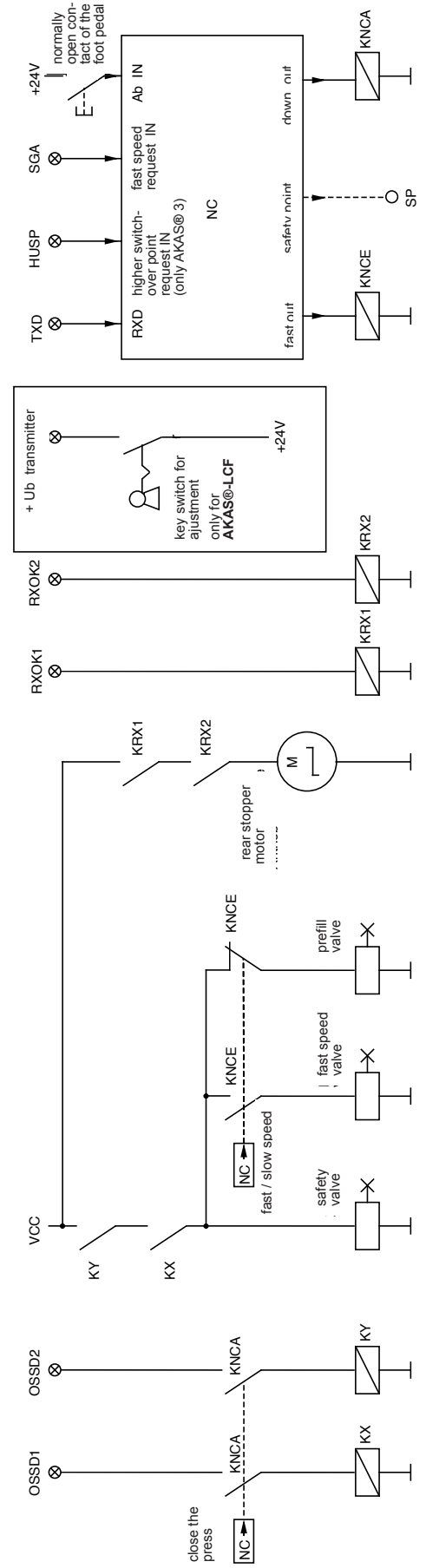

1. operation with additional Safety PLC
(e.g. Safety PLC FPSC)

The safety PLC (e.g. **FPSC**) is responsible for the fast speed / slow speed position control and provides this state to the AKAS® inputs SGO, SGS and SP vis a signal line. (see **wiring diagram 1/S. 33**)
 in **fast speed**: at **SGO, SGS and SP = 0 V**
 in **blanking range**: by **bending flat sheets at SGO, SGS and SP = + 24 V**
 in **slow speed**: at **SGO, SGS and SP = + 24 V**
 During this, the safety PLC must monitor the signal line to the AKAS® for eventual short-circuits against potential conducting lines.

2. monitoring of the foot pedal

In the operating modes "without additional Safety PLC" the **monitoring of the foot pedal** is permanently present. AKAS® activates the safety outputs OSSDs only if the foot pedal is permanently pressed. AKAS® monitors both positions of the foot pedal and requires:

if **the foot pedal is released**: at **FUO = +24 V** and at **FUS = 0 V** (see **wiring diagram 4a/p. 31**)
 if **the foot pedal is pressed**: at **FUO = 0 V** and at **FUS = + 24 V**

The monitoring function is able to monitor even 2 connected foot pedals, if two operators work at the press brake and if the foot pedals are correctly wired as shown in **wiring diagram 4b/p. 36**.

In the operating modes "with additional Safety PLC" the **monitoring of the foot pedal** can be cancelled, by selecting: "equivalent switching inputs for enabling the closing stroke".

In this case, both AKAS® inputs **FUS** and **FUO** are triggered **+ 24 V**, if a closing movement of the press brake is wanted.

wiring of foot pedal for one-man operation operation with monitoring of the foot pedal

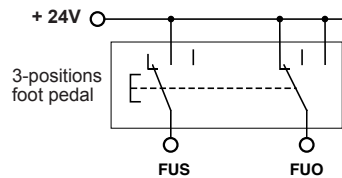

wiring diagram 4a/p.31

wiring of foot pedal for one-man operation operation without monitoring of the foot pedal

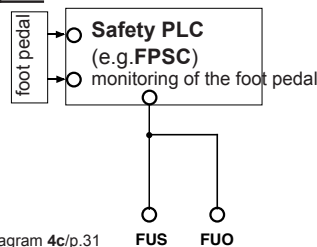

wiring diagram 4c/p.31

wiring of foot pedals with key switch for one - or two-man operation operation with monitoring of the foot pedal

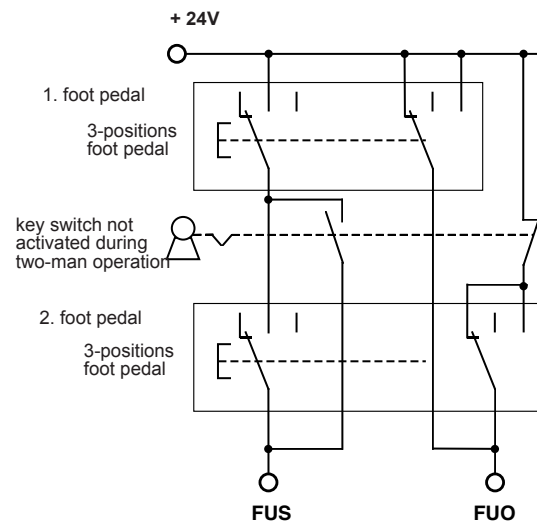

wiring diagram 4b/p.31

3. soft-breaking when the foot-pedal was released
(foot pedal response delay)

During the operating modes without additional safety PLC, a **foot pedal response delay** of the **AKAS® safety outputs (OSSDs) of about 30 ms** after the release of the foot pedal during the fast speed closing stroke can be selected.

When the foot pedal is checked also by the machine control, the control will execute an easier, smoother breaking via the proportional valves of the closing movement during this time, just before the OSSDs of the AKAS® disable the other closing stroke valves.

4. trail way control



The overrun traverse control is realized by a cam switch with a normally closed contact. For this, the length of the cam must correspond to the allowable overrun traverse plus the hysteresis of the cam switch. The maximum allowable overrun traverse must not exceed the value programmed via the dip switch positions in the support of the **AKAS®-3F**. This overrun traverse cam must be mounted in a way that the press is in the maximum closing speed when the cam switch is opened by the cam, and the stroke is started out of the upper dead center of the machine.

The overrun traverse test is carried out after every voltage reset and must be repeated every 24 hours. After the successful overrun traverse test, the press must be at first opened for the execution of one bending stroke. The adjustment controll-LEDs are flashing slowly until the press brake is not opened.

If the overrun traverse is too long, the cam does not open the overrun traverse cam switch when the closing movement is stopped, and the AKAS will prevent the complete bending strokes in fast speed.

If the overrun traverse control is not carried out by the AKAS®, the machine control must carry out an overrun traverse test at least after a voltage reset. This overrun traverse test must be repeated within the next 30 hours.

5. Control of the stop contactors (EDM)

AKAS® monitors in a safe way both positions of the stop- and the fast speed closing state of the contactor position monitors and switching contactors and requires:

in **fast speed state** at **EDMS = + 24 V** and at **EDMO = 0 V**

in **Stop state** at **EDMS = 0 V** and at **EDMO = + 24 V** (see **wiring diagram 2/p.39**)

During the **closing movement in slow speed**, **EDMO has to be = 0 V, EDMS is not monitored.**

After the release of the safety switching outputs (OSSDs) the AKAS® requires a switch-over of the EDM signals no later than 300 ms + the programmed tolerance enhancement.

In the operating modes with additional safety PLC (e.g **FPSC**) the safety PLC must carry out the monitoring of the stop contactors.

6. Monitoring of the door- and the Emergency OFF-circuits, Emergency-OFF of the Motor-driven Rear stoppers

The protective doors and the emergency OFF-buttons are evaluated by double-channel inputs. As soon as at least one input is disabled, i.e. is in OFF state, the closing movement will be stopped immediately by switching OFF of the OSSDs, and the movement of the rear stoppers is prevented by the disabling of the double channeled release **RXOK1 and RXOK2**. A continuation of the press operation is only possible if all relevant protective switching circuits are disabled and then closed again, and if afterwards the respective reset button is activated.

If the protective side doors are opened, AKAS® permits the movement of the rear stoppers after having activated the respective reset button. The closing movement of the press is permitted only during slow speed state. For this, AKAS® requires the prevention of the fast speed by the NC, by disabling the output SGA . AKAS® monitors the slow speed state during the closing movement. During this, the protective field of the AKAS® is **not** active.

During operation with foot pedal monitoring (antivalent foot pedal contacts) , the reset is carried out after the disabling and re-enabling of the Emergency-OFF-Circuits and of the lateral protective metal grids. This is carried out by activation of a normally closed contact butto., which is connected in series to the normally closed foot pedal contact at FUU (see **wiring diagram 2/p.30 u. 5b/p.32**) .

The Reset after the disabling and re-enabling of the rear protective grid is carried out during the operation with EDM by activation of a normally closed contact button, which is connected in series to the normally closed contactor controls at EDMO. (see **wiring diagram 5b/p.32**). During the operation without foot pedal monitoring (equivalent triggering of FUU and FUS) the reset of all protective circuits is carried out by a normally open contact which is connected between + 24 V and EDMO. (see **wiring diagram 5a/p.32**)

a. Reset button for rear safeguard at operating mode without EDM
b. Reset button for all Protective doors and emergency OFFs at operating mode without monitoring of the footpedal

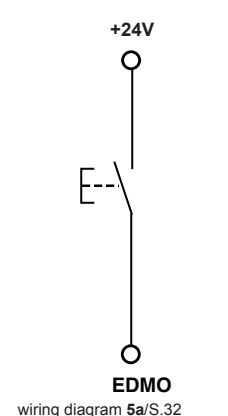

Protective doors and emergency OFFs

at operating mode with EDM / protective doors equivalent switching / with monitoring of the footpedal

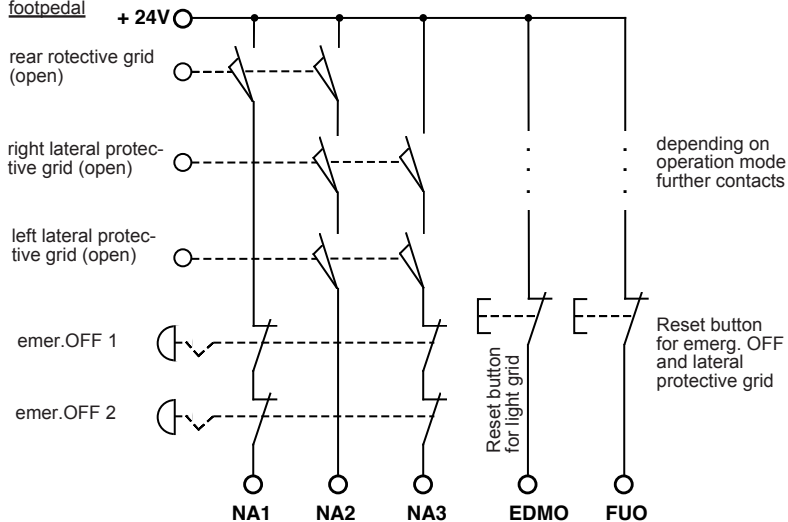

The emergency-OFF-circuits are equivalent switching, i.e. the emergency-OFF-buttons must have 2 normally closed contacts. When laying out the circuits of the protective doors, you may choose from either the equivalent switching protective door contacts, i.e. 2 normally open contacts per door switch, or anti-valent switching contacts, i.e. only one normally open and normally closed contact per door switch. The second possibility, however, is only available with the operation modes without additional safety PLC. The connection of the emergency OFF- circuits and the equivalent protective door contacts to the reset buttons when EDM is selected, is shown on **wiring diagram 2/p.30**.

6a. Rear safeguarding with lightgrid with equivalent switching outputs

	Receiver			
	ULVT	TLVT	ULCT	TLCT
+24V	7	7	1, 2, 4	1, 2, 4
0V	6	6	7	7
OSSD1	3	1	5	5
OSSD2	4	2	6	6

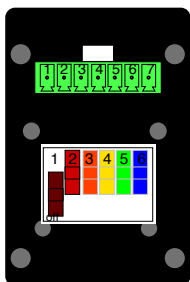

ULVT / TLVT:
Dip-switches (see picture)
-without restart interlock
-without EDM
-OSSD equivalent

ULCT / TLCT:
programming the operation mode of the lightgrid:
-without restart interlock
-without EDM

Instead of using a rear protective metal grid, a safety light grid with equivalent switching outputs, e.g. type Fiemler ULVT / TLVT or ULCT / TLCT as shown in **wiring diagram 6/S.33** is possible.

Protective doors and emergency OFFs and light grid ULVT / TLVT or ULCT / TLCT for rear safeguarding
at operating mode equivalent protective door control pairs / with EDM / with monitoring of the foot pedal / with Start interlock for the lightgrid

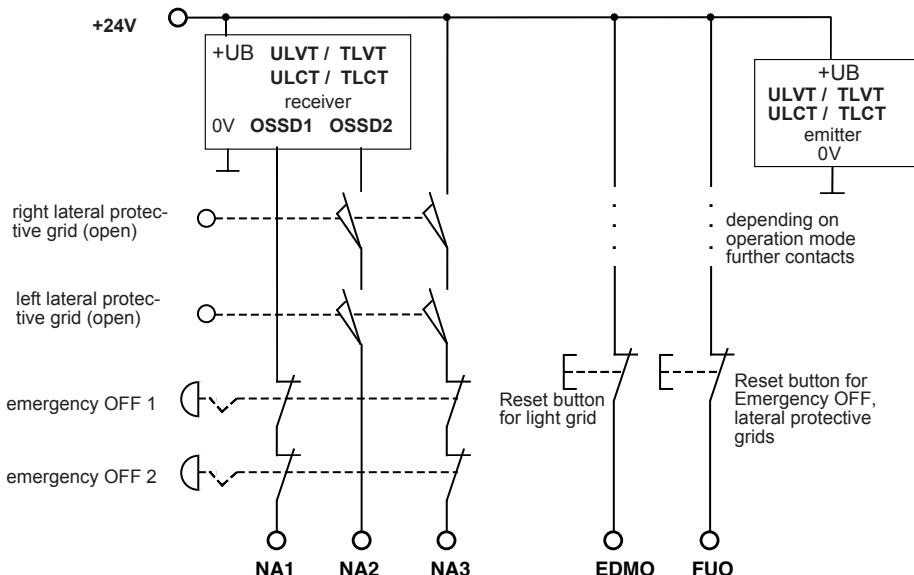

wiring diagram 6/S.33



Only to use the operation modes D...D... or F...F...!
These modes activates Start interlock for the rear safety lightgrid! (see chapter 6.5.2)

If the connected lightguard does not detect all possible cross circuit and short circuit on the outputs OSSD 1 and OSSD2 you have to wire them in a way that no cross and short circuit is possible.

6b. Rear safeguarding with lightgrid with antivalent switching outputs

As alternative, the connection of a light grid with antivalent switching outputs is also possible, like p.e. the Fiemler light grid EU2K 500/2. **Wiring Diagram 7/p.33** shows the connection of the Fiemler light grid EU2K 500/2 as a rear safeguard. In this case, the switches of the lateral protective grids must have antivalent switching contacts (1 normally closed and 1 normally open contact each) and the operating mode with antivalent switching protective door circuits must be selected. In this case, the connector 1 at the transmitter of the **EU2K 500/2** must be wired to the output S_EU2K of the AKAS®.

ble, the lateral protective grids are not monitored. Every switching-over of the selector, the reset button must be activated for the Emergency-OFF circuits and the circuits of the lateralprotective doors.

Protective doors and emergency OFFs and light grid EU2K 500/2 for rear safeguarding
at operating mode antivalent protective door control pairs with EDM / with monitoring of the foot pedal

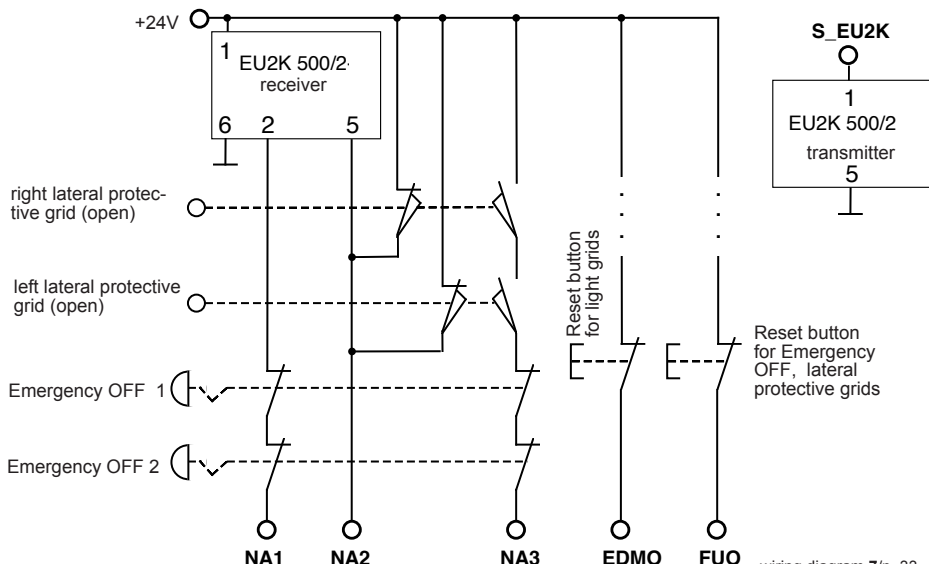
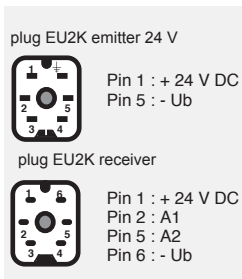

wiring diagram 7/p. 33

7. Installation operating mode, i.e. protection by monitored slow speed without activated protective field during operation with door monitoring

A selector switch provides the possibility to choose between operating mode with activated protective field of the AKAS® and fast closing speed or operating mode with protection only by monitored slow speed closing, see **Wiring diagrams 8/p.34 und 9/p.34**. If the selector switch is activated, the protective field of the AKAS® is muted (bridged). This state is displayed by the shining muting lamp. By disabling of its **output SGA**, AKAS® requires the NC to carry out only cycles in slow speed, which is monitored by the AKAS®. Given the fact that in this operating mode, only cycles in slow speed are possible, the lateral protective grids are not monitored. Every switching-over of the selector, the reset button must be activated for the Emergency-OFF circuits and the circuits of the lateral protective doors.

operation with equivalent switching protective door contacts

operation with **activated protective field of the AKAS® and slow speed closing movement** (selector not activated)
 operation with **only protection by monitored slow speed closing movement** (selector switch activated)

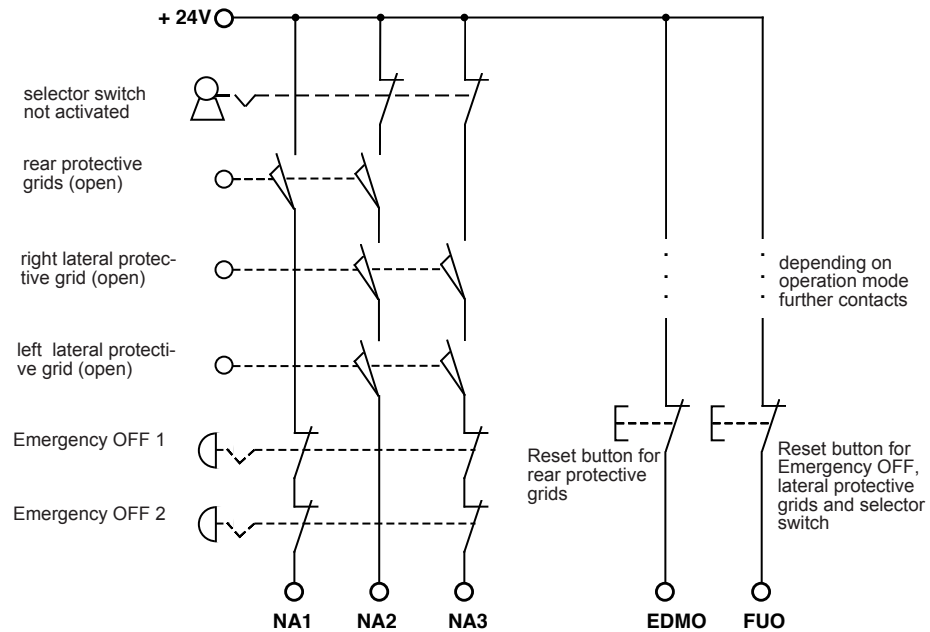

Wiring diagram 8/p.34

operation with antivalent switching protective door contacts

operation with **activated protective field of the AKAS® and slow speed closing movement** (selector not activated)
 operation with **only protection by monitored slow speed closing movement** (selector switch activated)

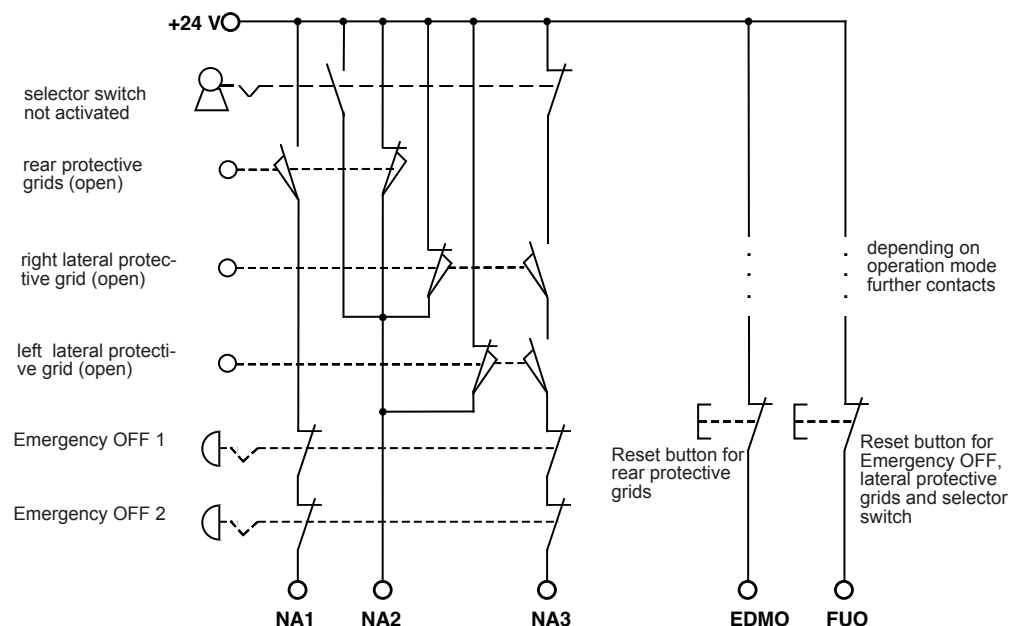

Wiring diagram 9/p.34

8. slow speed traverse information

During the operation with slow speed traverse information, the upper receiver element (E1) are only muted if a +24 V signal is given to KAST. This signal is provided by a traverse measuring system (e.g. Fiessler AMS, or NC) which indicates that the traverse has been actually covered. By this, the upper receiver element remain activated as long as possible even in the case of a very low slow speed, and intermediate stops during slow speed. By this, even in slow speed range, protection by the AKAS® is provided until the introduction of the operator's fingers between bending punch and sheet metal is made impossible. The protection of receiver E1 remains thus independent of time up to a closing movement at slow speed of 5mm. Connection: see **wiring diagram 10/S.35**.

connection with slow speed traverse information

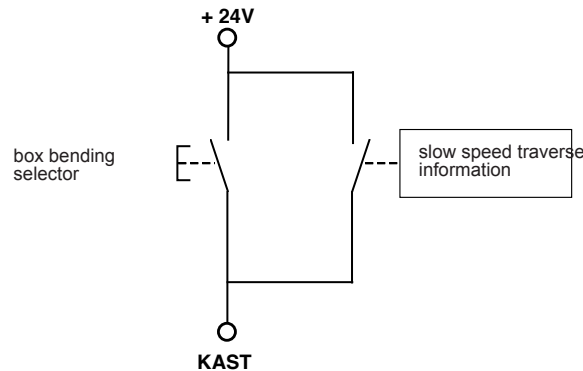

wiring diagram 10/p.35

9. selectable switch-over time tolerance of the valve position monitors

AKAS® dynamically monitors the valve position signals, i.e. the individual states of the valve position signals must change within a certain time. The basic tolerances for the switching-over of the valve position monitors from stop state into closing movement and from fast speed movement into slow speed movement or vice-versa can be enhanced by additional 300 ms.

The basic tolerances have the following values:

Switching-over from stopped condition into closing movement after the enabling of the OSSDs: 300 ms, (only with operating mode "Monitored EDM")

Switching-over into the slow speed condition when the start is within the range of the safety point (SP = + 24V): 100 ms after from the detection of the closing movement condition by the EDM, i.e. 100 ms after the enabling of the OSSDs during operating mode "without EDM".

Switching-over into the fast speed condition when the start is outside the safety point (when SP = 0): 100 ms after the detection of the closing movement condition by the EDM, i.e. 100 ms after enabling of the OSSDs during operating mode "without EDM".

Switching-over into the slow speed condition, start with request for slow speed (200 ms after SGA = 0 has been sent to NC): 70 ms after the detection of the closing movement condition by the EDM, i.e. 70 ms after the enabling of the OSSDs during operating mode "without EDM".

Programming of the integrated safety functions via Hex-switches 6.4.2

AKAS®-3PF

By the use of 4 Hex switches different operating modes can be selected.

The Hex-switches must always be programmed in pairs (1 and 3, 2 and 4). Within each pair, equal values must be programmed.

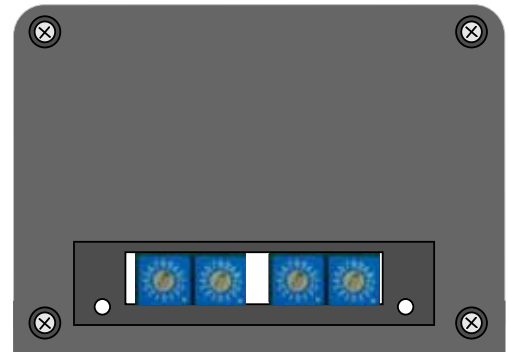

Hexswitches 1 2 3 4

1. Operating modes without additional safety control

with / without monitoring of protective doors / monitoring of the emergency off circuits (inputs equivalent)

Hex-switches 1 and 3 Hex-switch-positions	Start / Stop Closing Moving		Start interlock for the rear lightgrid	over-run traverse control	Monitoring of protective doors / Emergency OFF <u>equivalent</u> switching	Hex-switches 2 and 4 Hex-switch-positions	EDM stop valves monitoring	slow speed traverse information	* switching over tolerance enhancement of the valve position monitors
	Monitoring of the foot pedal <u>antivalent</u>	soft-breaking when the foot-pedal was released							
8	with	with	without	without	without	0	without	without	+ 0 ms
9	with	without	without	without	with	1	without	without	+ 100 ms
A	with	with	without	with	without	2	without	without	+ 200 ms
B	with	without	without	with	with	3	without	without	+ 300 ms
C	with	without	without	without	without	4	without	with	+ 0 ms
D	with	without	with	without	with	5	without	with	+ 100 ms
E	with	without	without	with	without	6	without	with	+ 200 ms
F	with	without	with	with	with	7	without	with	+ 300 ms
						8	with	without	+ 0 ms
						9	with	without	+ 100 ms
						A	with	without	+ 200 ms
						B	with	without	+ 300 ms
						C	with	with	+ 0 ms
						D	with	with	+ 100 ms
						E	with	with	+ 200 ms
						F	with	with	+ 300 ms

with monitoring of protective doors (inputs antivalent) / monitoring of the emergency off circuits (inputs equivalent)

Hex-switches 1 and 3 Hex-switch-positions	Start / Stop Closing Moving		overrun traverse control	EDM stop valves monitoring	Monitoring of the protective doors <u>antivalent</u> switching Monitoring of the Emergency OFF <u>equi-</u>	Hex-switches 2 and 4 Hex-switch-positions	slow speed traverse information	* switching over tolerance enhancement of the valve position monitors
	Monitoring of the foot pedal <u>antivalent</u>	soft-breaking when the foot-pedal was released						
0	with	with	without	without	with	8	without	+ 0 ms
1	with	with	without	with	with	9	without	+ 100 ms
2	with	with	with	without	with	A	without	+ 200 ms
3	with	with	with	with	with	B	without	+ 300 ms
4	with	without	without	without	with	C	with	+ 0 ms
5	with	without	without	with	with	D	with	+ 100 ms
6	with	without	with	without	with	E	with	+ 200 ms
7	with	without	with	with	with	F	with	+ 300 ms



*** Attention!**
Select always the shortest possible switching over tolerance enhancement of the valve position monitors!

The Hex-switches must always be programmed in pairs (1 and 3, 2 and 4). Within each pair, equal values must be programmed.

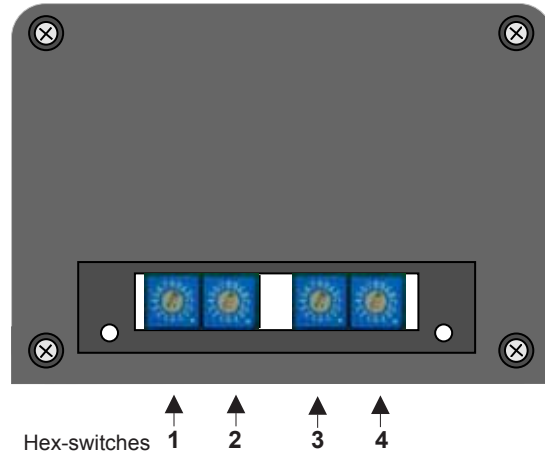

2. Operating modes with additional Safety control (e.g.. Safety PLC FPSC)

Hex-switches 1 and 3 Hex-switch-positions	Start / Stop closing moving inputs for release of closing stroke FUS / FUO		overrun traverse control	Monitoring of protective doors / Emergency OFF equivalent switching	Hex-switches 2 and 4 Hex-switch-positions	EDM Stop valve monitoring	slow speed traverse information	* switching over tolerance enhancement of the valve position monitors
	Monitoring of the foot pedal antivalent							
0	without	equivalent	without	without	0	without	without	+ 0 ms
1	without	equivalent	without	with	1	without	without	+100 ms
2	without	equivalent	with	without	2	without	without	+ 200 ms
3	without	equivalent	with	with	3	without	without	+ 300 ms
4	with	antivalent	without	without	4	without	with	+ 0 ms
5	with	antivalent	without	with	5	without	with	+100 ms
6	with	antivalent	with	without	6	without	with	+ 200 ms
7	with	antivalent	with	with	7	without	with	+ 300 ms



*** Attention!**

Select always the shortest possible switching over tolerance enhancement of the valve position monitors!

example: Hex switch 1 2 3 4
Hex switch position 3 1 3 1

Hex-switches 1 and 3 Hex-switch-positions	Start / Stop closing moving inputs for release of closing stroke FUS / FUO		overrun traverse control	Monitoring of protective doors / Emergency OFF equivalent switching	Hex-switches 2 and 4 Hex-switch-positions	EDM Stop valve monitoring	slow speed traverse information	* switching over tolerance enhancement of the valve position monitors
	Monitoring of the foot pedal antivalent							
3	without	equivalent	with	with	1	without	without	+100 ms

Displaying of conditions by the Muting lamp

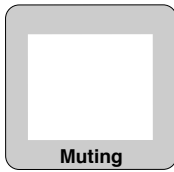

lamp is out (flashing is hardly recognizable) : during the closing movement the protective field is at least partially activated

lamp is constantly on: The protective field of the AKAS® is not activated. AKAS® only permits closing strokes in slow speed.

The lamp is flashing slowly : about once per second: EDM is not in Stop condition, or the rear reset button must be released, or the press brake must be opened completely in order to quit the slow speed range to enable the triggering of SP = 0.

The lamp is flashing rapidly: about five times per second: AKAS® is in interlock state. Carry out a voltage reset.

Displaying of conditions by the Adjustment control-LEDs

see also page 21

LEDs are flashing slowly about once per second: Press has successfully stopped at the cam during the over-run traverse test, only when the cam is free again, the OSSDs can be enabled again. The adjustment control-LEDs are flashing slowly until the press brake is not opened completely.

AKAS®-3PF: E2, E4, E6

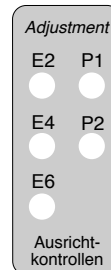

Indicator LEDs

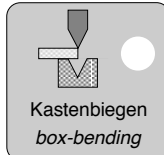

LED is on if box bending funktion is activated

	LED-displays for incomings and exits	AKAS®- ...F	AKAS®- ...M
RXOK2	Outputs for release of rear stoppers	LEDs are lit if the rear stoppers are free *	-
RXOK1			
NLW	Input for Overruntraverse controll	LED is lit if the cam is not activated	-
NA1	Inputs for control of protective grids or doors and emergency-off circuits	equivalent protective door contacts: LEDs are lit if all protective door circuits/Emergency OFF circuits are closed. antivalent protective door contacts: NA1 and NA3 are lit, NA2 is dark if all protective door circuits/Emergency OFF circuits are closed	-
NA3			
NA2			
FUS	Inputs for press start / stop (release of closing stroke)	antivalent inputs: FUS is lit, FUO is dark if foot pedal is activated. equivalent inputs: FUS /FUO are lit if foot pedal is activated.	
FUO			
EDMO	Input for stop contactor control	EDMO: stop = 1 / fast speed = 0 / slow speed = 0 EDMS: stop = 0 / fast speed = 1 / slow speed = x	-
EDMS			
SP	Input for safety point	SP is lit if safety point is reached	
SGA	Output for demand for slow speed	SGA is lit if fast speed is permitted	
SGO	Input for position control in slow speed	antivalent inputs SGO/SGS: stop =not 1/1; fast speed =1/0; slow speed =0/1 equivalent inputs SGO/SGS: stop =1/1 or 0/0; fast speed =0/0; slow speed =1/1	
SGS			

* If the **lateral protective doors are open**: all other protective doors / protective circuits must be closed. NA1 must be lit. NA2, NA3 must be dark if the protective door contacts are equivalent.

If the protective door contacts are antivalent, NA2 must be lit, and NA3 must be dark. If necessary check the contacts). If the RXOK-LEDs are not lit, activate the RESET-Button(s). If the LEDs still remain dark, open and close all other protective doors / protective circuits, then activate the RESET-Button(s).

If the **lateral protective doors are closed**: all other protective doors / protective circuits must be equally closed. NA1, NA2, NA3 must be lit if the protective door contacts are equivalent.

If the protective door contacts are antivalent, NA1 and NA3 must be lit, and NA2 must be dark. (If necessary check the contacts). If the RXOK-LEDs are not lit, activate the RESET-Button(s). If the LEDs still remain dark, open and close all protective doors / protective circuits, then activate the RESET-Button(s).

Status messages, warnings and Error reports via the RS 232 serial interface

The AKAS® displays messages by serial transfer via its RS 232 interface; transfer format: 9600 baud, 1 start bit, 8 data bits, 1 stop bit. The messages have even parity and will be repeated at least three times. The time gap between 2 messages is at least 100 ms. At the receiver, defective messages are gated, because only those messages are accepted that fulfil the following conditions: an even parity, successful reception of the message is provided if it is received at least 3 consecutive times and if its complete compatibility to one of the message possibilities indicated below is given.

There are different kinds of messages:

- **Information concerning the status** of the AKAS® or **handling directions** for the operator, here are Bit 0 and Bit 1 = 1,
- **Warnings** concerning errors that, if received three times one immediately after the other, may lead to the interlocking of the AKAS®, here is Bit 0 = 0 and Bit 1 = 1,
- **Error reports** of the interlocked AKAS®, here is Bit 0 = 1 and Bit 1 = 0.

Status messages, handling directions for the operator (binary xxxxxx11)

background grey: other message or no message, if monitoring functions are partially cancelled

message transferred byte decimal	operating mode	description possible text in the display system	handling directions
3		front reset button does not enable	verify reset button and cable leading to the normally closed contact of the foot pedal if interrupted
3	antivalent foot pedal inputs without protective circuit monitoring	normally closed contact of the foot pedal does not enable	<i>verify the cable leading to the normally closed contact of the foot pedal if interrupted</i>
3	<i>equivalent foot pedal inputs</i>	error at the request for release of the closing stroke	<i>check the equivalent switching lines going FUO and FUS. They are evaluated as "different"</i>
7		Mutinglamp does not light up	see message 63
11	<i>only AKAS...P</i>	SP too early	Before the SP input is activated the receiver element E2 respectively E4 must be interrupted by the Fieessler magnet plate. Set the SP output of your machine to a corresponding value.
15		Stop at the overrun traverse cam	during overrun traverse test
15	<i>without overrun traverse control</i>	-	-
23		open the press completely in order to quit the safety point range	if this message is displayed after every pressing and releasing of the foot pedal, check the SP connecting circuit for short circuits
27	<i>only AKAS...P</i>	<i>E3 interrupted</i>	<i>Check whether slowspeedsignal comes after Interrupting the E3</i>
39		release foot pedal	
43		overrun traverse OK	during overrun traverse test
43	<i>without overrun traverse control</i>	-	-
51		rear reset button is defective or the EDM is not in Stop status	check rear reset button for short-circuits
51	<i>without EDM</i>	<i>rear RESET button is defective</i>	<i>check rear reset button for short circuit</i>
51	<i>without protective circuit monitoring</i>	<i>EDM is not in Stop Status</i>	<i>Check EDM Signals</i>
51	<i>without EDM and without protective circuit monitoring</i>	<i>wrong potential at EDMO or EDMS</i>	<i>check the connectors for short circuits</i>
63		Mutinglamp does not light up	open the press completely. If this message is repeated at the following new stroke and the internal muting lamp does not light up, there is an internal error at the version that has no connection option of an external muting lamp. With the version with external connection option of an external Muting lamp, the connection KAST must be checked for short-circuits on -
71	<i>only AKAS...P</i>	<i>max. fastspeed exceeded</i>	<i>Check whether slowspeedsignal comes later than 800ms after controlling SP</i>
83		overrun traverse too long	during overrun traverse test
83	<i>without overrun traverse control</i>	-	-
95		overrun traverse measurement has not been carried out	possible reason: the protective field is interrupted, or the protective circuit is interrupted, or the foot pedal is released, or no fast speed during the overrun traverse measurement, evtl. because the stroke for the overrun traverse measurement has not been started by the UDC of the machine. Open the press completely and carry out a new stroke for the overrun traverse measurement.
95	<i>without overrun traverse control</i>	-	-

Status messages, handling directions for the operator (binary xxxxxx11)

background grey: other message or no message, if monitoring functions are partially cancelled

message transferred byte decimal	operating mode	description	handling directions
99		no overrun traverse test was carried out because of slow speed during overrun traverse test	set the switch-over point onto the normally required position, open the press until the machines reaches its UDC and carry out a new stoke for overrun traverse measurement
111		interrupted protective circuit	Release all protective grids and Emergency off buttons
111	no monitoring of the protective circuit	Internal error	if this is displayed again after the voltage reset, a verification by Fiessler Elektronik is necessary
119		error within the protective circuits, re-disable and enable them	open again all protective grids and Emergency off buttons and close them again so that a possible bad contact is activated again
119	no monitoring of the protective circuit	Internal error	if this is displayed again after the voltage reset, a verification by Fiessler Elektronik is necessary
123		error within the protective grids, re-open and close them	re-open and close the protective grids so that a possible bad contact is activated again
123	no monitoring of the protective circuit	Internal error	if this is displayed again after the voltage reset, a verification by Fiessler Elektronik is necessary
131		lateral protective grids are open, CLOSE!	close all lateral protective grids
135		lateral protective grids are open, i.e. protection by AKAS® is cancelled, activate RESET	Press can close only in slow speed
135	no monitoring of the protective circuit	Internal error	if this is displayed again after the voltage reset, a verification by Fiessler Elektronik is necessary
139		error within lateral grids or Emergency-OFF-button, open and close them once more	open and close again all lateral protective grids and all Emergency-OFF-buttons so that a possible bad contact is activated again
147		error within rear grids or Emergency-OFF-button, open and close them once more	open and close again all rear protective grids and all Emergency-OFF-buttons so that a possible bad contact is activated again
147	no monitoring of the protective circuit	Internal error	if this is displayed again after the voltage reset, a verification by Fiessler Elektronik is necessary
159		Emergency OFF activated	re-enable emergency OFF button
159	no monitoring of the protective circuit	Internal error	if this is displayed again after the voltage reset, a verification by Fiessler Elektronik is necessary
163		rear protective grid is open	close rear protective grid
163	no monitoring of the protective circuit	Internal error	if this is displayed again after the voltage reset, a verification by Fiessler Elektronik is necessary
175		lateral and rear protective grids are open	close all protective grids
175	no monitoring of the protective circuit	Internal error	if this is displayed again after the voltage reset, a verification by Fiessler Elektronik is necessary
183		activate reset button for the rear protective grid	reset must be activated after the opening and closing of the protective grids
183	no monitoring of the protective circuit	-	-
187		open the press after overrun traverse test	Press has successfully stopped at the cam during the overrun traverse test, only when the cam is free again, the OSSDs can be enabled again The adjustment control-LEDs are flashing slowly until the press brake is not opened completely.
187	no monitoring of the protective circuit	-	-
195		box bending function is selected	-
207		bending of flat sheet metal	-
215		muting	AKAS@ provides only indirect protection by permitting the closing movement only in slow speed
219		foot pedal is released	during the closing movement, the foot pedal was released
231		interruption of the protective field	during the closing movement, the protective field was interrupted
235		activate emergency-OFF-reset of the grids	after the opening and closing of a protective grid, a reset must be carried out
235	no monitoring of the protective circuit	-	-
243		key switch is activated	Disable key switch. If the same message remains displayed, there is a risk of short-circuiting of the normally open foot pedal contact.

Warnings (binary xxxxxx10)
error reports (binary xxxxxx01)

Warnings issued when several consecutive malfunctions occur that lead to an interlocking of the AKAS with displayed error reports. The interlocking status can be cancelled only by a voltage reset.

background grey: other message or no message, if monitoring functions are partially cancelled

Warning transferred decim. byte	error transferred decim. byte	operating mode	description	reason for the error
6	5		possible text in the display system EDM does not respond even though the OSSDs are released	If this happens during fast speed: valve position monitors do not switch in fast speed position or at an interruption in the EDMS circuit. If this happens during Muting: EDMS and EDMO are both at + 24 V
6	5	<i>no monitoring of the protective circuit</i>	-	-
10	9		slow speed signal error	When switching over from fast speed into slow speed, at SGO remains+ 24 V
10	9	<i>with additional safety PLC (e.g. FPSC)</i>	slow speed signal error	<i>When switching over fast speed into slow speed, the triggering of the SGS and the SGO is antivalent instead of equivalent</i>
18	17		machine stops at the overrun traverse cam/ cam switch does not conduct	in the case of "warning": open press completely, in the case of "error": check cable and cam switch
18	17	<i>overrun traverse control</i>	-	-
30	29		no complete slow speed position in the Muting status	This message is displayed when the stroke is started in slow speed range or with a slow speed request SGA = 0 and if there is no complete switch-over of the slow speed position monitors into slow speed. Check the SGA line for Short circuit to +24 V and check also the slow speed position monitors and their lines.
86	85		Problem release of the rear stoppers	line short circuiting of one RXOX circuit with another line
86	85	<i>no monitoring of the protective circuit</i>	internal error	<i>if this is displayed again after the voltage reset, a verification by Fiessler Elektronik is necessary</i>
90 / 102	89 / 101		Problem fast speed -- slow speed request	line short circuiting of the SGA circuit with another line
106	105		fast speed/slow speed signals are faulty in stop status	during operation without safety PLC, both EDMS and EDMO are at + 24 V at the same time in stopped status.
106	105	<i>with additional safety PLC (e.g. FPSC)</i>	fast speed/slow speed signals are faulty in stop status	<i>The triggering of the SGS and the SGO is antivalent instead of equivalent</i>
114	113		OSSD- error	line short circuiting of the OSSD circuits with other lines
126	125		short circuit of the the muting lamp line	only possible at the version with external Muting lamp, otherwise: internal problem
130	129		problem at request for higher switchover point:	line short circuiting of the HUSP circuit with other lines
142	141		Muting lamp should not light up, release box bending button	short circuit in box bending button or line short circuiting of the KAST circuit with other lines
146	145	<i>only AKAS 3P</i>	E2 / SP error or lateral die cover missing	The SP signal is active at the beginning of the stroke but receiver element E2 is free. The lateral die cover is missing or SP signal is not set to the correct value
150	149		problem at pressing of foot pedal	line short circuiting of the foot pedal circuits FUO and FUS with other lines
154	153	<i>only AKAS...P</i>	SP_SGS short-circuit error	SP and SGS comes at the same time while bending flat sheet
166	165		Hex switches deadjusted	Readjust the Hex switches onto the selected operating mode, then carry out a voltage reset. If the error repeats itself, a repair by Fiessler Elektronik is necessary.
170	169		invalid Hex switch position	Turn HEX switch into a permitted position
198	197		external transmitter signals are received	The transmitter is triggered although the foot pedal is released, or a transmitter from another AKAS® focuses the receiver. This must be prevented by adequate constructional measures.
interlocking without prior warning	201	<i>with additional safety PLC (e.g. FPSC)</i>	unequal slow speed connections	<i>This error happens only during the operating mode "for connection to safety PLC" if the signals at the SGO and the SGS are not exactly the same.</i>
interlocking without prior warning	237		disable key switch - voltage reset	<i>The key switch of the front reset switch have been activated when the foot pedal was pressed, or there is an error within the foot pedal, or the front reset button does not close.</i>
246	245		internal error	If this message is displayed immediately after a voltage reset, there is an EMC problem or an internal failure of the appliance.

Service

If you have questions that cannot be answered by reading this operation instruction manual, please contact us directly.

When calling, please have the following data ready:

- Exact unit type and model
- Serial number(s)
- Symptom of the malfunction and/or fault description

Fiessler Elektronik GmbH & Co. KG
Kastellstraße 9
D-73734 Esslingen

Phone: 0711 / 91 96 97 - 0
Fax: 0711 / 91 96 97 - 50
E-mail info@fiessler.de

Maintenance

The transmitter- and receiver lenses should be cleaned with a soft cotton swab at least once a month.

The spindle of the support should be lubricated with machine oil after 6 months.

The press brake protection systems AKAS® are maintenance-free with the exception of the supports.

On request by the customer, Fiessler Elektronik GmbH & Co. KG carries out the acceptance test and annual inspections.

In addition, seminars providing customers with training in annual inspections are held at regular intervals.

Warranty

The company Fiessler Elektronik GmbH & Co. KG refuses to accept any warranty claims if the device has been opened or if it has been modified.

Returning a unit

If, in the case of default, the necessity of returning the unit to Fiessler Elektronik arises, it will be very advantageous for a fast default diagnosis if the following topics are observed and observed:

- exact description of malfunction:
- did you frequently notice malfunctions at the machine where the light curtains are installed?
- any defaults or malfunctions in the past?
- etc..
- which operating mode has been used with this unit?

The more exactly the malfunction is described, the more accurate and faster we can determine it and repair it.

AKAS3P M/F

Normal stroke from TDC >11mm above clamping point with max. machine overrun of 5mm

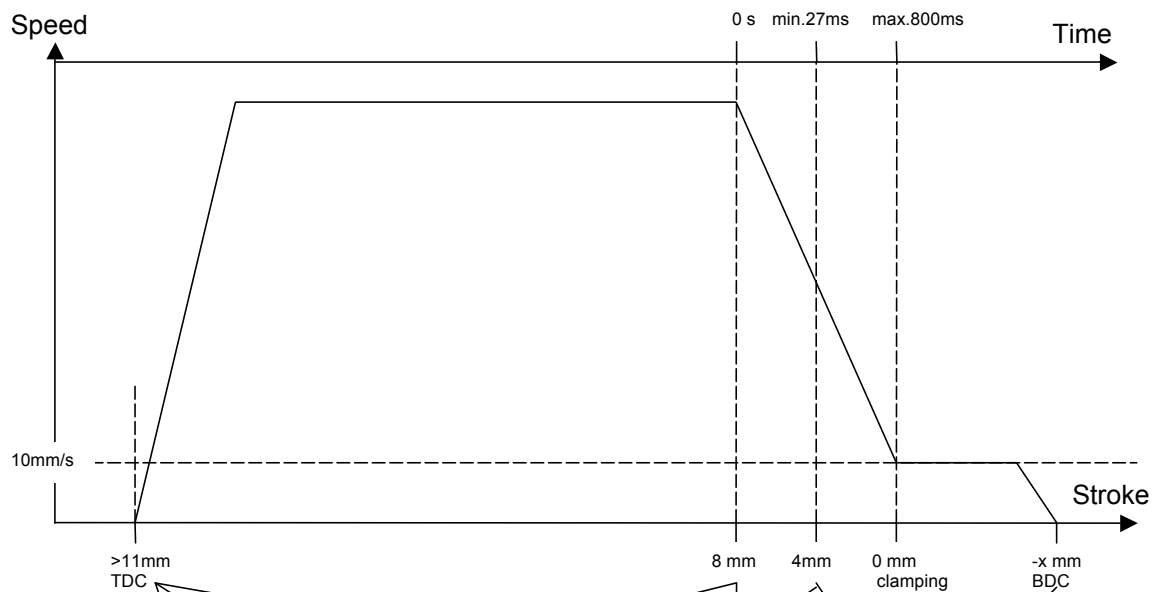

Status	Stop	FP pressed	Fast closing	1.half of breaking	2.half of breaking	Bending speed
Safety PLC OUT						
FUO	0/1	1/0	1/0	1/0	1/0	1/0
FUS	0/0	1/1	1/1	1/1	1/1	1/1
SGO	0/X	0/1	0/1	0/1	0/1	1/0
SGS	0/0	0/0	0/0	0/0	0/0	1/1
NC out						
SP	0	0	0	1	1	1
Manual signal OUT						
KAST	0	0	0	0	0	0
AKAS OUT						
OSSD1	0	0	1	1	1	1
OSSD2	0	0	1	1	1	1
SGA	1	1	1	1	1	1
HUSP	0	0	0	0	0	0
Receivers						
E5	inactive	active 1	active 1	blanked	blanked	blanked
E6	inactive	active 1	active 1	blanked	blanked	blanked
E3	inactive	active 1	active 1	active 1	active 1	blanked
E4	inactive	active 1	active 1	active 1 (for 27ms)	blanked	blanked
E1	inactive	active 1	active 1	blanked	blanked	blanked
E2	inactive	active 1	blanked	active 0	blanked	blanked

0/1 = AKAS 3PM = 0 / AKAS 3PF = 1

active 1 means receiver is active and has to be free

active 0 means receiver is active and has to be interrupted

AKAS3P M/F

Normal stroke from 11mm \geq TDC > 8mm above clamping point with max. machine overrun of 5mm.

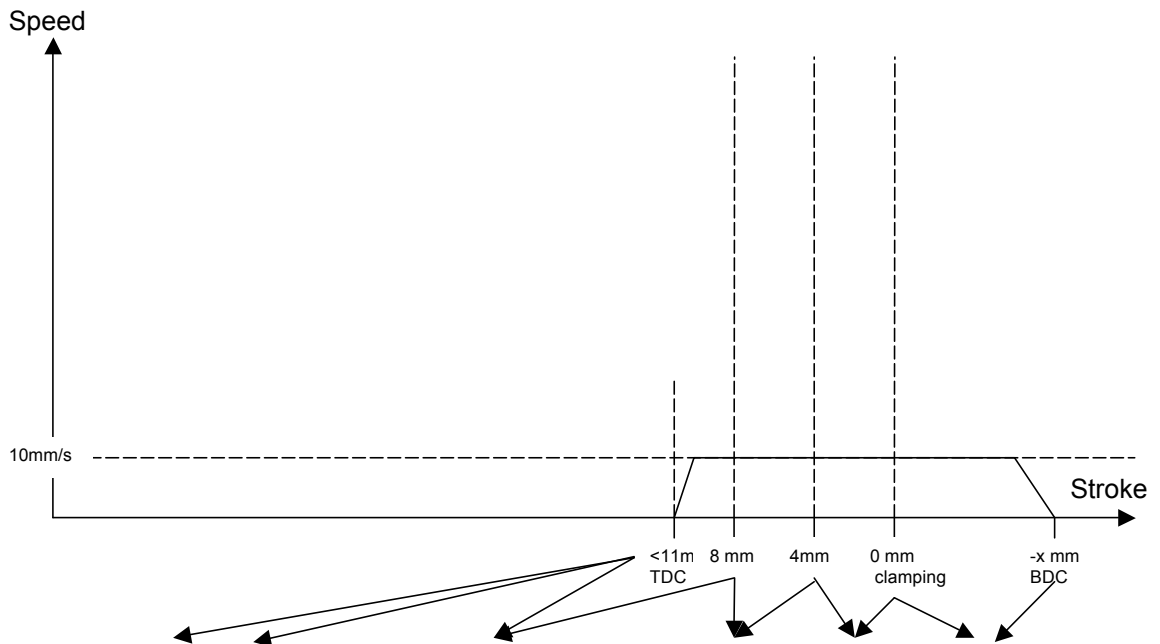

Status	Stop	FP pressed	slow closing	slow closing	slow closing	Bending speed
Safety PLC OUT						
FUO	0/1	1/0	1/0	1/0	1/0	1/0
FUS	0/0	1/1	1/1	1/1	1/1	1/1
SGO	0/X	0/X	1/0	1/0	1/0	1/0
SGS	0	0/0	1/1	1/1	1/1	1/1
NC out						
SP	0	0	0	1	1	1
Manual signal OUT						
KAST	0	0	0	0	0	0
AKAS OUT						
OSSD1	0	0	1	1	1	1
OSSD2	0	0	1	1	1	1
SGA	1	0	0	0	0	0
HUSP	0	0	0	0	0	0
Receivers						
E5	inactive	active 1	blanked	blanked	blanked	blanked
E6	inactive	active 1	blanked	blanked	blanked	blanked
E3	inactive	active 1	blanked	blanked	blanked	blanked
E4	inactive	active 1	blanked	blanked	blanked	blanked
E1	inactive	active 1	blanked	blanked	blanked	blanked
E2	inactive	active 0	blanked	blanked	blanked	blanked

0/1 = AKAS 3PM = 0 / AKAS 3PF = 1

active 1 means receiver is active and has to be free

active 0 means receiver is active and has to be interrupted

AKAS3P M/F

Normal stroke from TDC >= 8mm above clamping point with max. machine overrun of 5mm

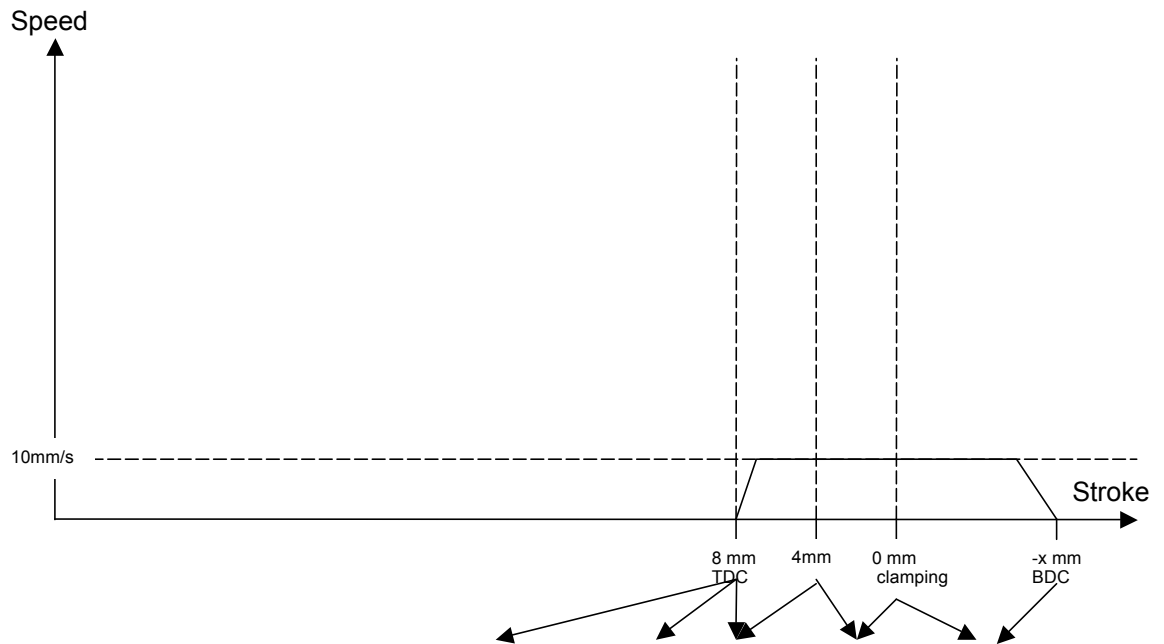

Status	Stop	FP pressed	slow closing	slow closing	Bending speed
Safety PLC OUT					
FUO	0/1	1/0	1/0	1/0	1/0
FUS	0/0	1/1	1/1	1/1	1/1
SGO	0/X	0/X	1/0	1/0	1/0
SGS	0/0	0/X	1/1	1/1	1/1
NC out					
SP	1	1	1	1	1
Manual signal OUT					
KAST	0	0	0	0	0
AKAS OUT					
OSSD1	0	0	1	1	1
OSSD2	0	0	1	1	1
SGA	1	0	0	0	0
HUSP	0	0	0	0	0
Receivers					
E5	inactive	blanked	blanked	blanked	blanked
E6	inactive	blanked	blanked	blanked	blanked
E3	inactive	blanked	blanked	blanked	blanked
E4	inactive	blanked	blanked	blanked	blanked
E1	inactive	blanked	blanked	blanked	blanked
E2	inactive	blanked	blanked	blanked	blanked

AKAS3P M/F

Stroke with initial interrupted protection field from 11mm \geq TDC > 8mm above clamping point with max. machine overrun of 5mm

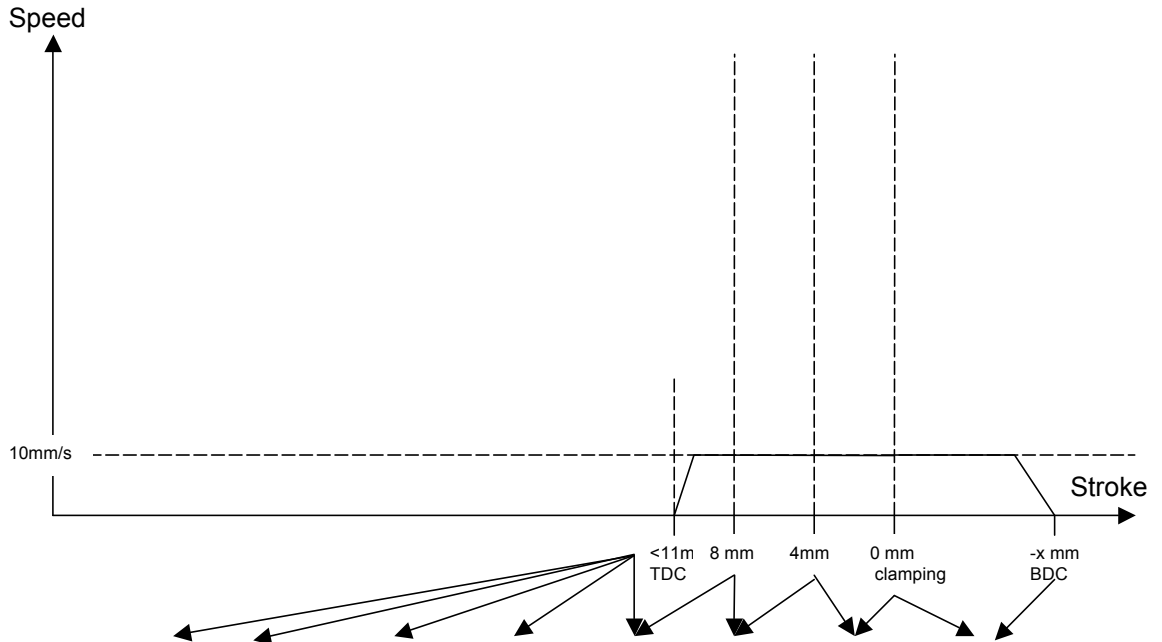

Status	Stop	FP pressed	FP depressed	FP pressed	slow closing	slow closing	slow closing	Bending speed
Safety PLC OUT								
FUO	0/1	1/0	0/1	1/0	1/0	1/0	1/0	1/0
FUS	0/0	1/1	0/0	1/1	1/1	1/1	1/1	1/1
SGO	0/X	0/1	0/1	0/1	1/0	1/0	1/0	1/0
SGS	0/0	0/0	0/0	0/0	1/1	1/1	1/1	1/1
NC out								
SP	0	0	0	0	0	1	1	1
Manual signal OUT								
KAST	0	0	0	0	0	0	0	0
AKAS OUT								
OSSD1	0	0	0	0	1	1	1	1
OSSD2	0	0	0	0	1	1	1	1
SGA	1	1	1	0	0	0	0	0
HUSP	0	0	0	0	0	0	0	0
Receivers								
E5	inactive	active 0?	inactive	active 0?	blanked	blanked	blanked	blanked
E6	inactive	active 0?	inactive	active 0?	blanked	blanked	blanked	blanked
E3	inactive	active 0?	inactive	active 0?	blanked	blanked	blanked	blanked
E4	inactive	active 0?	inactive	active 0?	blanked	blanked	blanked	blanked
E1	inactive	active 0?	inactive	active 0?	blanked	blanked	blanked	blanked
E2	inactive	active 0?	inactive	active 0?	blanked	blanked	blanked	blanked

0? means some of E1 – E5 are interrupted and E6 may be interrupted

AKAS3P M/F (same as for AKAS3 M/F)

Box bend stroke from TDC >12mm above clamping point with max. machine overrun of 5mm

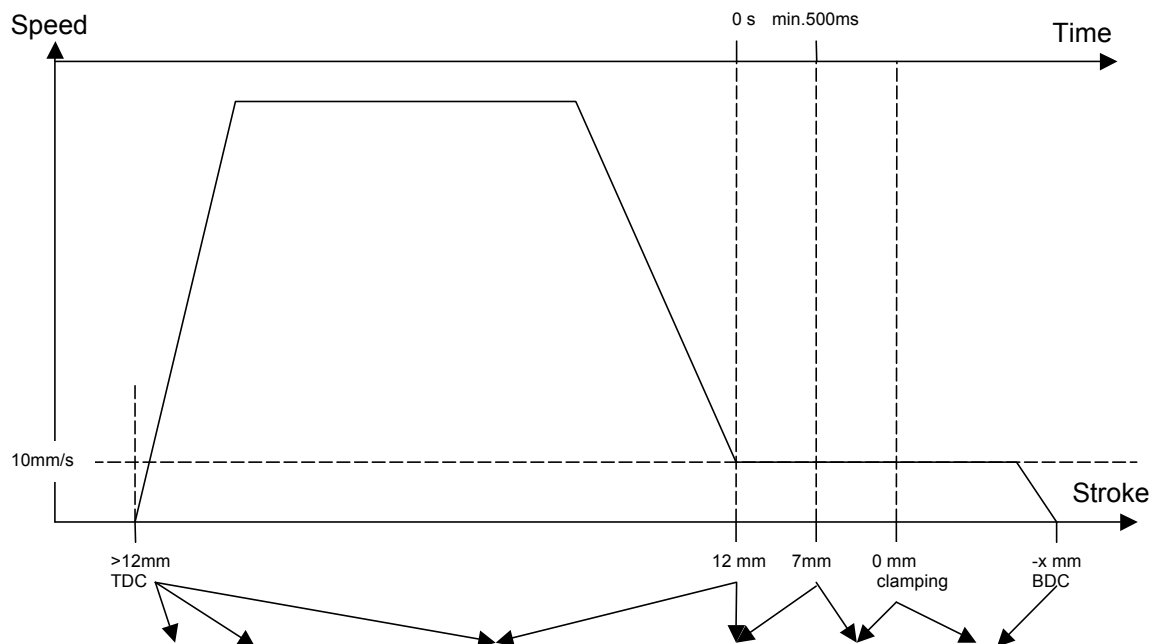

Status	Stop	FP pressed	Fast closing	1.half of slow closing	2.half of slow closing	Bending speed
Safety PLC OUT						
FUO	0/1	1/0	1/0	1/0	1/0	1/0
FUS	0/0	1/1	1/1	1/1	1/1	1/1
SGO	0/X	0/X	0/1	1/0	1/0	1/0
SGS	0/0	0/0	0/0	1/1	1/1	1/1
NC out						
SP	0	0	0	1	1	1
Manual signal OUT						
KAST	1	0	0	0	0	0
AKAS OUT						
OSSD1	0	0	1	1	1	1
OSSD2	0	0	1	1	1	1
SGA	1	1	1	1	1	1
HUSP	1	1	1	1	1	1
Receivers						
E5	inactive	blanked	blanked	blanked	blanked	blanked
E6	inactive	blanked	blanked	blanked	blanked	blanked
E3	inactive	blanked	blanked	blanked	active 1	blanked
E4	inactive	blanked	blanked	blanked	blanked	blanked
E1	inactive	active 1	active 1	active 1 (for 500ms)	blanked	blanked
E2	inactive	active 1	active 1	blanked	blanked	blanked

active 1 means receiver is active and has to be free

**AKAS® accessories
(electronic equipment)**

part designation	order code
AKAS® Muting System w. integrated overrun traverse control AMS/N, complete (incl. 2 magnetic sensors with 10m & 5m cables, 1 magnetic tape)	AMS/N/K
Muting lamp white, 230V / 7W	UMLW
Safety double foot pedal FL2-528ZSD4-U	FS2-528ZSD4-U
AKAS® Foot pedal for box-bending function	AKAS/Ped

**AKAS® accessories
(mechanical equipment)**

part designation	order code	page
AKAS® mounting kit (not swivable) with U-shaped holder, for lateral mounting	AKAS/AS/U	18
swiveling adaptor for Holder AKAS/AS/U	AKAS/AS/U/S	18
AKAS®-LC Mounting Kit (not swivable) with Holder 2 for mounting at the back for the AKAS® transmitter and receiver (one pair)	AKAS/AS/3/LC/ZM	

Inspection Sheet	Inspection of a press brake safeguarded by a press brake protection system AKAS®
No.: _____	
Date: _____	

customer's order number: _____ company: _____ address: _____ department: _____ Post Code/City: _____ phone: _____ Fax: _____ attending staff: _____ inspecting company: _____ inspector: _____	Hex switch position: _____ machine builder: _____ machine type: _____ Serial no.: _____ machine control by: _____ machine located at: _____ inventory no.: _____ cost centre: _____ type of control: _____ Muting box no.: _____ AKAS® no.: _____ AMS no.: _____ Sensors 1/2, nos: _____
---	---

- 1. Inspection:**
- first inspection
 maintenance contract existing
 regular inspection requested
 regular inspection
 cost estimate of maintenance contract requested

2. Installation:

detection range: _____ m optional swivable holder at: transmitter receiver

- 3. Visual Inspection of the Installation**
- | | |
|--|--|
| <input type="checkbox"/> 3.1 correct electric connection | 3.10 max. work speed: _____ mm/s |
| <input type="checkbox"/> 3.2 cables damage free | 3.11 max. fast speed: _____ mm/s |
| <input type="checkbox"/> 3.3 strain relief at both sides of cable loop | 3.12 Overrun traverse of the AKAS® is: _____ mm
when interrupted during fast speed motion |
| <input type="checkbox"/> 3.4 cable protected against all mechanical damages by metal sheet | |
| <input type="checkbox"/> 3.5 correct position of vertical light grid (not too far behind from bending line) | |
| <input type="checkbox"/> 3.6 correct position of vertical light grid (distance sufficiently behind the bending line) | |
| <input type="checkbox"/> 3.7 transmitter beams are parallel to the ram | |
| <input type="checkbox"/> 3.8 work speed < 10 mm/s | |
| <input type="checkbox"/> 3.9 test with test rod passed | |

After viewing of the electrical diagrams, the electrical integration of the AKAS® can be accepted as safe according to safety class 4 EN 954T.1, under the condition that the machine control is wired exactly as shown in the said diagrams.

- 4. Cooperation between the AKAS® system and the machine**
- 4.1 The stopping of the AKAS® during the dangerous movement complies with the safety level of safety category 4
 4.2 control elements : OK
 4.3 closing movement during foot operated motion with AKAS® only possible when foot pedal remains pressed down
 4.4 interruption of the AKAS® during fast speed: OK
 4.5 interruption of the AKAS® during work speed: OK
 4.6 operation mode „foot-fast motion“ is possible only when AKAS® is activated
 4.7 AKAS® is switched off in all operation modes where AKAS® is not activated
 4.8 Muting signal is given if the gap above metal sheet corresponds to distance between „lower edge E2 and tool tip+2mm“
 4.9 Muting signal from valve position signal during work stroke or AMS
 4.10 Muting signal monitored by AKAS®, Safety PLC e.g. FPSC or machine control
 4.11 Muting signal monitored by machine control

Muting point in mm: _____

- 4.21 PLC input is controlled by ESPE output.
 4.22 Muting signal unsafe
 4.23 Safety level of the following machine control is lower than ESPE
 4.24 Secondary control is single channel

 4.30 The protective effect might be cancelled by a malfunction of the press.

If tops 3 and 4.1 - 4.10 are not completely ticked, or if one or more of the tops 4.21 - 4.24 are ticked, the AKAS® installation is **not** in a faultless condition. In this case, the protective effect by the system is not completely provided.

5. Comments

Inspection Badge: badge issued badge not issued

The inspection refers only to the functionality check of the AKAS® according to the regulations. It does **not** replace the safety check of the machine itself. All modifications of the AKAS® or of the machine may impair the protective effect of the AKAS®. In this case, the inspection must be repeated.

_____, _____

Company Management

**Konformitäts-
erklärung**

(gemäß Anhang II 1 A 2006/
42/EG)

Wir
Fiessler Elektronik
Kastellstr. 9
D-73734 Esslingen,

erklären in alleiniger Verantwortung,
daß das Produkt
AKAS 3PM, AKAS 3PF,
Berührungsloswirkende Schutz-
einrichtung Typ 4 nach EN 61496-
1 zur Absicherung des Gefahren-
bereiches von Abkantpressen
nach EN 12622.

auf die sich diese Erklärung bezieht,
mit den folgenden Normen oder nor-
mativen Dokumenten übereinstim-
men:

EN 61496-1:2008, IEC 61496-
2:2006, EN 12622 (Final Draft
2009), EN ISO 13849-1:2008,
EN62061_2005

Gemäß den Bestimmungen der
Richtlinie
2006/42/EG
2004/108/EG

Die Schutzziele der Niederspan-
nungsrichtlinie (2006/95/EG)
wurden gemäß Anhang I, Nr.
1.5.1 der Maschinenrichtlinie
eingehalten.

Die Geräte entsprechen der
Laserklasse 1

**Declaration of
conformity**

(according appendix II 1 A
2006/42/EG)

We
Fiessler Elektronik
Kastellstr. 9
D-73734 Esslingen,

declare under our sole responsibility
that the product
AKAS 3PM, AKAS 3PF,
electro-sensitive protective equip-
ment type 4 according to EN
61496-1 for protecting the dange-
rous area of pressbrakes accor-
ding to EN 12622.

to which this declaration relates is in
conformity with the following stan-
dards or other normative documents

EN 61496-1:2008, IEC 61496-
2:2006, EN 12622 (Final Draft
2009), EN ISO 13849-1:2008,
EN62061_2005

following the provisions of Directive
2006/42/EG
2004/108/EG

The protection goals of the Low
Voltage Directive (2006/95/EC)
have been complied with in ac-
cordance of Annex I No.1.5.1 of
the Machinery Directive.

The products are conform with
the laser class 1

**Modèle recommandé
de déclaration de con-
formité**

(conforme appendice II 1 A
2006/42/EG)

Nous
Fiessler Elektronik
Kastellstr. 9
D-73734 Esslingen,

déclaration sous notre seule
responsabilité que le produit
AKAS 3PM, AKAS 3PF,
Dispositif de protection
électrosensible type 4 suivant EN
61496-1 pour la protection des zo-
nes dangereuse des presses
plieuses suivant EN 12622.

auquel se réfère cette déclaration est
conforme aux normes ou autres do-
cuments normatifs

EN 61496-1:2008, IEC 61496-
2:2006, EN 12622 (Final Draft
2009), EN ISO 13849-1:2008,
EN62061_2005

conformément aux dispositions de
Directive
2006/42/EG
2004/108/EG

Les objectifs de protection de la
directive "basse tension" (2006/
95/CE) ont été respectées con-
formément à l'annexe I n °
1.5.1 de la directive Machines.

Les produits sont conforme avec
la classe laser 1

EG-Baumusterprüfung / EC type-examination certificate / certificat d'examen CE de type Nr. : 44 205 12 016401
TÜV NORD CERT GmbH

Esslingen, den / the / le 15.02.2012



Götz Fiessler / Geschäftsführer / Dokumentationsbevollmächtigter
/ managing director / authorized for documentation
/ gérant / mandataire de la documentation

Electrosensitive protective equipment	The press brake protection AKAS® is an electrosensitive protective device (ESPE). ESPE is characterised by the fact that a hazardous motion becomes interrupted or prevented if the light beams produced between the transmitter and receiver unit are interrupted.
Safety category 4 PL e, SIL3	AKAS ® meets Safety Category 4 according to EN 954, e PL (Performance Level) according to EN ISO 13849-1: 2008 and SIL 3 according to EN 62061:2005 Devices to safety category 4, PL e, SIL 3 are self-monitoring sensitive protective equipment and provide the highest Safety class among the sensitive protective equipment.
Self-monitoring	The electrosensitive protective device (ESPE) switches automatically into the "safe state" when it is faulty.
Standard Installation range	Maximum distance between transmitter and receiver is 8 m (For longer range please get in contact with Finessler Elektronik or your local dealer).
Max. Upper tool length	The maximum upper tool length is 6m. (For longer range please get in contact with Finessler Elektronik or your local dealer).
Overrun	The part of the hazardous motion still taking place after interrupting the light beam.
Overrun traverse	The distance covered during the overrun (e.g. by the ram of a press).
Overrun period	The duration of the overrun traverse.
Response time	The time that elapsed after light beam interruption until the switching action occurs.
Valve or contactor control	Before every release of the output contacts the contactor control is checking whether the switching elements connected (relays, contactors or valves) have been released. A renewed release of the output contacts is only possible if the switching elements connected have been released. Thus a dangerous failure of switching-elements (relays, contactors or valves) caused by the hazardous motion is prevented.
Start interlock	After initial operation or after a power supply interruption a renewed "enabling" is blocked by the start interlock. The renewed release of the switching unit is only possible by closing and opening of the start entry.
Restart interlock	The restart interlock prevents any automatic releasing of the switching outputs after an interruption and re-enabling of the light beam (e.g. when penetrating the light beam).
Muting	Short-time safe by-pass of the press brake protection AKAS® during material movement, i.e. during a plate bending process.
Blanking	Selected receiver elements will be muted, all other receiver elements stay active.
Box-bending	By-pass of the receiver unit E3-E6 (AKAS®-3PM, AKAS®-3PF), during a box-bending process. Muting of the receiver elements E3 – E6 (AKAS®-3PM, AKAS®-3PF) during a boxbending stroke. This is required because the side panels of the box will interrupt E3 – E6

other Safety products



Safety Mats



Safety-Footpedal



Parametricable Safetycontrol FPSC



Press Brake Protection System AKAS



Safety-Light-Curtain

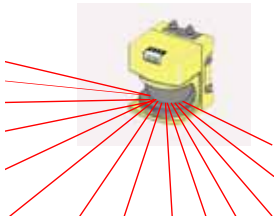

Proximity Laser Scanner



Single-Safety-Beam

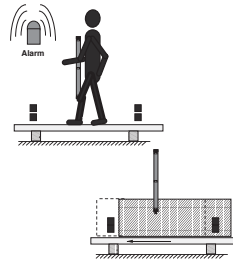

Safety-Light-Grid with muting function

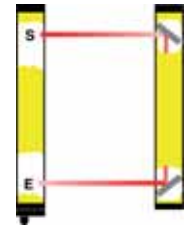

Safety-Light-Grid

Service

As a special feature for training our customers, Fiessler Elektronik offers one-day safety workshops. Our service team provides you with expert advice and information for the reliable integration of our safety equipment into your machine.

HOMOLOGATIONS

In order to ensure and maintain the high quality level of the Fiessler safety products, a quality control security system has been established early. Fiessler Elektronik holds the DIN ISO EN 9001 Certificate and, thanks to the company-owned EMC laboratory, all products must pass a inspection without exception before they leave the company. All safety equipment comply with the applicable national and international standards. Development and Design is made in close cooperation with the German employer's liability insurance associations. All homologations are obtained only after having passed strict tests by the German surveyor organisation TÜV.



AWARD OF

APPRECIATION

for exemplary performance in the development of the press brake protection system AKAS.

The award was bestowed upon Fiessler Elektronik by the ministry of trade and commerce of the federal state of Baden-Württemberg.



**Fiessler Elektronik
GmbH & Co. KG
Kastellstr. 9
D-73734 Esslingen**

Telefon: ++49(0)711-91 96 97-0
Fax: ++49(0)711-91 96 97-50
Email: info@fiessler.de
Internet: www.fiessler.de

Fiessler Elektronik has resrepresentations in all major industrial

